

PHILIPS **MAGNAVOX**

Video Cassette Recorder

VRX562AT



Owner's Manual

I M P O R T A N T !

Return Your Warranty Registration Card
Within 10 Days. See Why Inside.

Return your Warranty Registration card today to ensure you receive all the benefits you're entitled to.

Once your PHILIPS MAGNAVOX purchase is registered, you're eligible to receive all the privileges of owning a PHILIPS MAGNAVOX product. So complete and return the Warranty Registration Card enclosed with your purchase at once. And take advantage of these important benefits.

Warranty Verification

Registering your product within 10 days confirms your right to maximum protection under the terms and conditions of your PHILIPS MAGNAVOX warranty.

Owner Confirmation

Your completed Warranty Registration Card serves as verification of ownership in the event of product theft or loss.

Model Registration

Returning your Warranty Registration Card right away guarantees you'll receive all the information and special offers which you qualify for as the owner of your model.

PHILIPS MAGNAVOX

Congratulations on your purchase, and welcome to the "family!"



Dear PHILIPS MAGNAVOX product owner:

Thank you for your confidence in PHILIPS MAGNAVOX. You've selected one of the best-built, best-backed products available today. And we'll do everything in our power to keep you happy with your purchase for many years to come.

As a member of the PHILIPS MAGNAVOX "family," you're entitled to protection by one of the most comprehensive warranties and outstanding service networks in the industry.

What's more, your purchase guarantees you'll receive all the information and special offers for which you qualify, plus easy access to accessories from our convenient home shopping network.

And most importantly you can count on our uncompromising commitment to your total satisfaction.

All of this is our way of saying welcome-and thanks for investing in a PHILIPS MAGNAVOX product.

Sincerely,

Robert Minkhorst
President and Chief Executive Officer

P.S. Remember, to get the most from your PHILIPS MAGNAVOX product, you must return your Warranty Registration Card within 10 days. So please mail it to us right now!

Know these

safety symbols



This "bolt of lightning" indicates uninsulated material within your unit may cause an electrical shock. For the safety of everyone in your household, please do not remove product covering.

The "exclamation point" calls attention to features for which you should read the enclosed literature closely to prevent operating and maintenance problems.

WARNING: TO PREVENT FIRE OR SHOCK HAZARD, DO NOT EXPOSE THIS EQUIPMENT TO RAIN OR MOISTURE.

CAUTION: To prevent electric shock, match wide blade of plug to wide slot, and fully insert.

ATTENTION: Pour éviter les chocs électriques, introduire la lame la plus large de la fiche dans la borne correspondante de la prise et pousser jusqu'au fond.

For Customer Use

Enter below the Serial No. which is located on the rear of the cabinet. Retain this information for future reference.

Model No. _____
Serial No. _____

PHILIPS MAGNAVOX Visit our World Wide Web Site at <http://www.magnavox.com>

Welcome to your VCR owner's manual.

This manual has seven sections: Setting Up Your VCR; Description of Controls; Basic Operations; Recording; Playing; Stereo Features; and Information You May Need. The instructions explain all of the VCR's features, which are listed below. You cannot hurt your VCR by trying the features! So read on – and relax.

Features

- HQ (High Quality) System
- Automatic Channel Programming
- On-Screen Displays in English or Spanish
- Display Panel
- MTS (Multi-Channel Television Sound) System
- Hi-Fi Stereo Sound System
- Automatic Tracking Adjustment
- One Touch Recording
- Unattended (Timer) Recording
- Special Effects Playback: Forward and Reverse Searching; Still; Variable Slow; Frame Advance
- Remote Control: With Capability to Operate TV, Cable Box, and Digital Satellite System; With Lighted Buttons
- Repeat Playback
- Automatic Operation Features
- Real Time Counter
- Daylight-Saving Time
- The VCR Plus+ Programming System
- Search Functions: Time Search; Index Search; Record End Search; Skip Search
- Automatic Head Cleaner
- Automatic Clock Setting
- Memory Rewind Off
- Jog & Shuttle Control
- Remote Locator
- Cable Box Controller

Safety Precautions

Warning: To prevent fire or shock hazard, do not expose this equipment to rain or moisture.

FCC Warning: Any unauthorized changes or modifications to this equipment void the user's authority to operate it.

This VCR, equipped with a HQ (High Quality) system, is compatible with existing VHS (video home system) equipment. Philips Consumer Electronics Company recommends that you use only video cassette tapes that have been tested and inspected for use in two, four, six, and eight hour VCRs, and which are labeled with the  mark. The use of tapes that have not been inspected for use in two, four, six, and eight hour VCRs may result in poor picture quality and excessive deposits on the video heads, which may not be covered by the warranty if damage occurs.

Note to the Cable TV System Installer: This reminder is provided to call the Cable TV system installer's attention to Article 820-40 of the National Electrical Code, which provides guidelines for proper grounding – in particular, specifying that the cable ground shall be connected to the grounding system of the building, as close to the point of cable entry as possible.

Copyright 1997 Philips Consumer Electronics Company. All rights reserved. VCR Plus+, C³ and PlusCode are trademarks of Gemstar Development Corporation. The VCR Plus+ system is manufactured under license from Gemstar Development Corporation. With the VCR Plus+C³ system, this video cassette recorder can automatically select the appropriate channel on your compatible cable box. C³ and VCR Plus+C³ are trademarks of Gemstar Development Corporation.

Helpful Hint

- Before doing anything else, record the VCR's model and serial numbers in the spaces provided on page two. These numbers will help us assist you if you ever call for help.

4 Table of Contents

Setting Up Your VCR

Introduction	3
Table of Contents	4
Before Using Your VCR	5
Hookups Without a Cable Box	6-7
Hookups With a Cable Box/DSS Receiver	8-9
Hookups With a Stereo TV	10
Turning on Your VCR	11
Channel Memory	12-13
Setting the Clock	14-17
Daylight-Saving Time Selection	18
Language Selection	19
Setting the Remote to Operate a TV	20
Setting the Remote to Operate a Cable Box/Digital Satellite System	21
Remote Locator	22

Description of Controls

Remote Control Buttons	23-25
On-Screen Status Displays	26
VCR Display Panel	27
Front Panel	28
Rear Panel	29

Basic Operations

Playing	30
Recording	31

Recording

Recording One Channel/Watching Another	32
One Touch Recording	33
Timer Recording	34-37
Setting Up the Cable Box Controller	38-39
Setting Up the VCR Plus+ Programming System	40-41
Timer Recording With the VCR Plus+ Programming System	42-43
Rerecording (Tape Duplication)	44

Playing

Repeat Playback	45
Time Search	46
Index Search	47
Record End Search/Skip Search	48
Real Time Counter Memory	49
Special Effects Playback	50-51
Automatic Operation Features	52-53

Stereo Features

MTS Broadcast Stereo System	54-55
Hi-Fi Stereo Sound System	56-57

Information You May Need

Helpful Hints	58-59
Glossary	60
Specifications	61
Limited Warranty	62
Index	63
Supplied Accessories	64

Before Using Your VCR 5

Putting Batteries in the Remote Control

1

Remove the battery compartment lid on the bottom of the remote control by pressing the tab, then lifting the lid.

2

Place three AA batteries inside the battery compartment with their polarities (+ and – ends) aligned as indicated.

3

Replace the battery compartment lid.

Using the Remote Control

- Point the remote control at the VCR's remote sensor (see page 28) when using the remote control to operate the VCR. Point the remote control at the TV when using the remote control to operate the TV. Point the remote control at the Cable Box or Digital Satellite System when using the remote control to operate the Cable Box or Satellite System.
- Do not put objects between the remote control and the VCR.
- Before you use the remote control to operate your TV, you must first press the TV button.
- Before you use the remote control to operate your Cable Box or Digital Satellite System, you must first press the CBL/DSS button.
- When you press the POWER button on the VCR to turn on the VCR, the remote control beeps. (The exception is when you plug the VCR power cord into the wall outlet for the first time.) Press any button on the remote control to stop it. LOCATING REMOTE will appear on-screen. See page 22 for details.

Erasure Prevention

Video cassette tapes have record tabs to ensure that recordings are not accidentally erased.

1

To prevent accidental erasure, break off the tab with a screwdriver.

2

To record again, cover the hole with cellophane tape.

VCR maintenance

- In this VCR, use only tapes with the **VHS** mark.
- Make sure any light adhesive stick-on notes are removed from the video cassette tape before putting the tape in the VCR. Removable labels like these can jam the VCR.
- Periodic maintenance is required to maintain your VCR's excellent performance. This VCR has an Automatic Head Cleaner. However, the video heads will eventually require replacement, which should be performed only by an authorized service center.

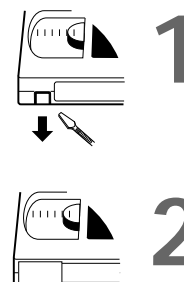
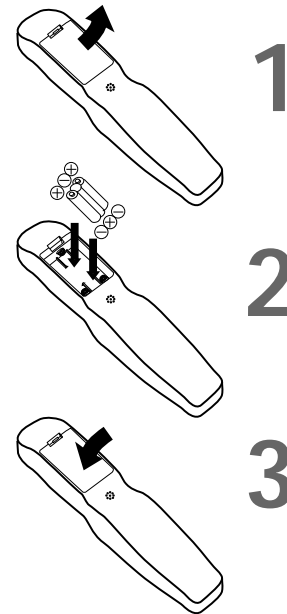

Helpful Hints

- The remote control and its batteries are supplied.
- Do not mix alkaline and manganese batteries.
- Do not mix old and new batteries.

6 Hookups Without a Cable Box

The basic VCR/TV connection – antenna/cable to VCR to TV – is shown below. If you have a Cable Box or a Digital Satellite System, please refer to pages eight-nine. If you have a Stereo TV, please go to page 10. After you hook up the VCR, please go to page 11 to turn on the VCR.

1

Disconnect the antenna or cable from your TV.

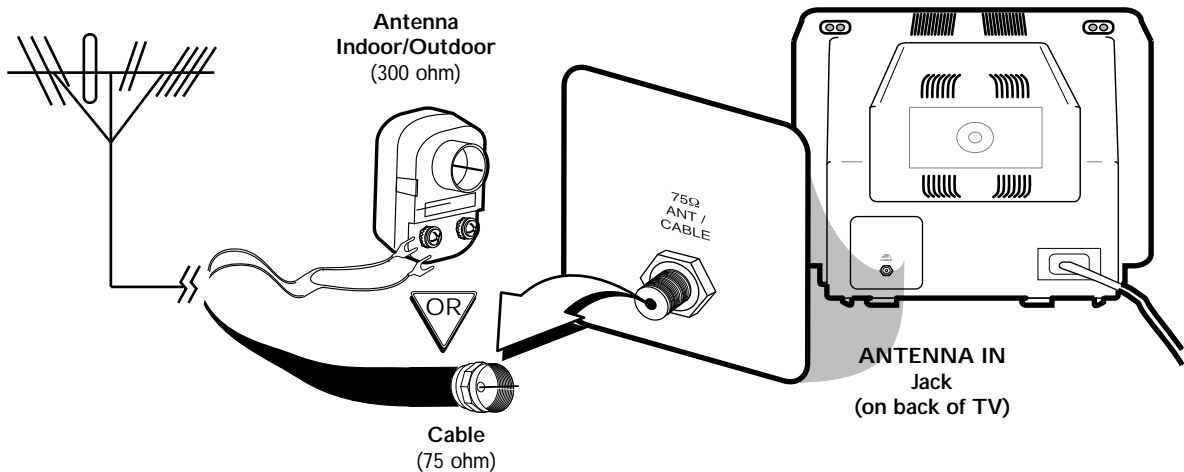

2

Connect the antenna or cable to the ANT(enna) IN Jack of your VCR.

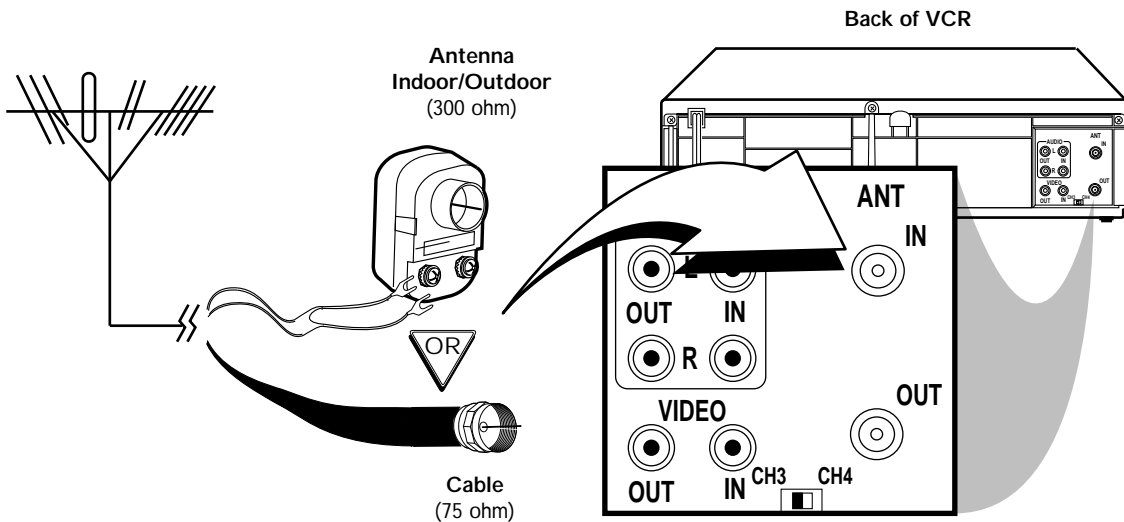

Hookups Without a Cable Box (cont'd) 7

3

Connect the RF coaxial cable (supplied) to the **OUT** Jack on the back of the VCR and to the **ANTENNA IN** Jack on the TV. (You may use either a snap-on type (supplied) or screw-on type of coaxial cable, whichever you prefer.)

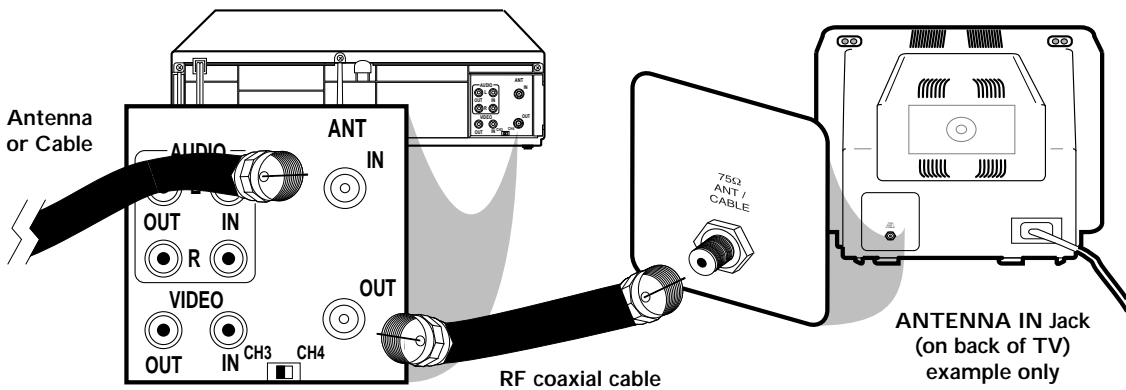

4

Plug in the TV and the VCR.

5

Set the **CH3/CH4** switch on the back of the VCR to **CH3** or **CH4**, whichever channel is not used or least used in your area. To operate your VCR with your TV, **set the TV to the same channel**. For example, when playing a tape, if the CH3/CH4 switch is set to CH3, the TV should be on channel 3.

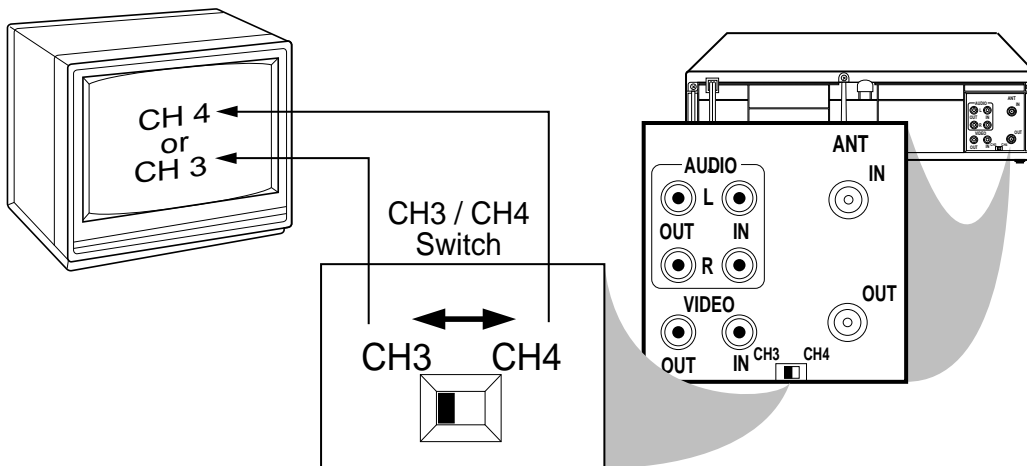

6

You are ready to turn on the VCR. Please go to page 11 before turning on the VCR.

8 Hookups With a Cable Box/DSS Receiver

This connection allows you to view any channel. After you connect the Cable Box/DSS Receiver, VCR, and TV as shown below, the features described on this page will be available.

1. Connect a Cable signal to the IN Jack on the Cable Box/DSS Receiver.

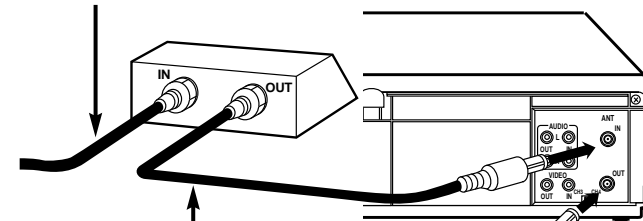

2. Use an RF coaxial cable (supplied) to connect the OUT Jack on the Cable Box/DSS Receiver to the ANT(enna) IN Jack on the VCR.

3. Use a second RF coaxial cable to connect the OUT Jack on the VCR to the TV's ANTENNA IN Jack.

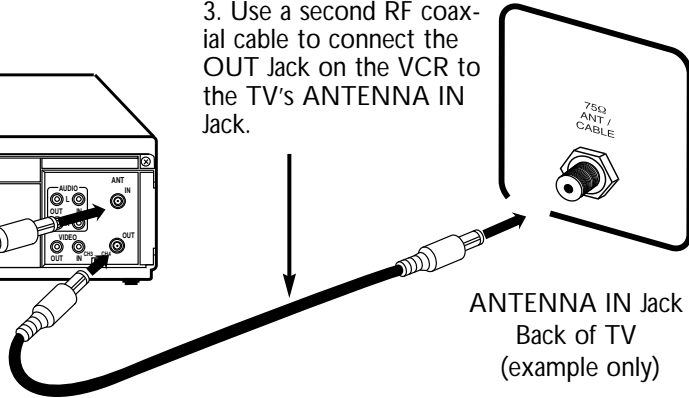

ANTENNA IN Jack
Back of TV
(example only)

Recording/Viewing Any Channel

1

With the VCR on and in VCR position (the VCR light will appear on the display panel), use the **CH(annel) Up/Down** buttons to set the VCR to the Cable Box/DSS Receiver output channel (channel 03 or 04).

2

Set the TV to the same channel to which you set the VCR.

3

Select the channel you want to watch or record at the Cable Box/DSS Receiver.

Watching TV With the VCR Off

1

Use the TV channel selector to set the TV to the Cable Box/DSS Receiver output channel (channel 03 or 04).

2

Select the channel you want to watch at the Cable Box/DSS Receiver.

Timer Recordings

With this connection, you may set a timer recording as described on pages 34-37. However, you must remember the following:

- You can only program a timer recording for one channel at a time.
- Set the TV and the VCR to the Cable Box/DSS Receiver output channel (channel 03 or 04).
- When you are prompted to enter the channel you want to record, select channel 03 or 04 (the Cable Box/DSS Receiver output channel). (This is step 5 on page 35.)
- Set your Cable Box/DSS Receiver to the channel you want to record.
- Leave the Cable Box/DSS Receiver on while you are recording.

Helpful Hints

- With this hookup, channels cannot be changed at the VCR. You must select channels at the Cable Box/DSS Receiver.
- You can not view a channel other than the one you are recording (the instructions on page 32 do not work with this hookup).
- You cannot program channels with this hookup (as discussed on page 12).
- If you set up the VCR's internal Cable Box Controller, the VCR will select the Cable Box channel automatically during a timer recording. You must place the Cable Box on top of the VCR. Details are on pages 38-39.
- Leave the Cable Box/DSS Receiver on while you are recording.

Hookups With a Cable Box/DSS Receiver (cont'd) 9

This connection allows you to program an unattended recording of more than one unscrambled channel and to watch one channel while recording another. After you connect the VCR, Cable Box/DSS Receiver, and TV as shown below, the features on this page will be available.

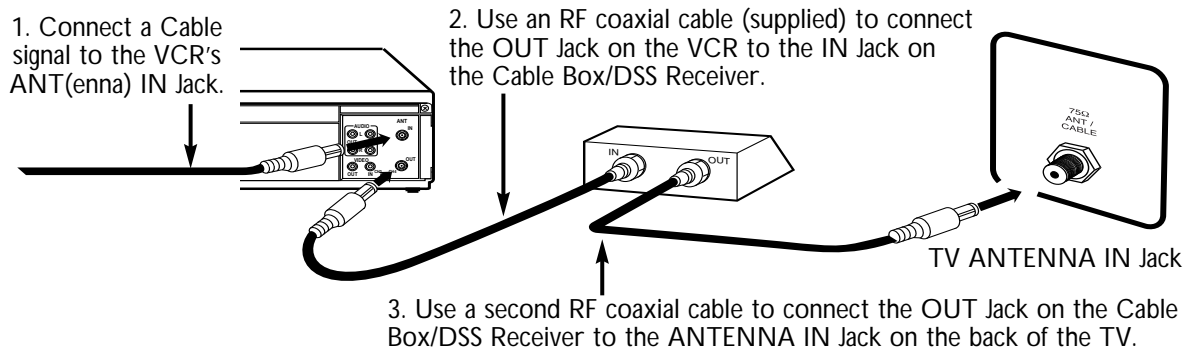

Recording One Channel/Watching Another

1

Put the Cable Box/DSS Receiver on the same channel as the VCR's CH3/CH4 switch. Put the TV on the same channel. With the VCR in VCR position (the VCR light will appear on the display panel), use the CH(annel) Up/Down buttons at the VCR to select the channel you want to record. **Start the recording.**

2

Press the **VCR/TV** button once to put the VCR in TV position. (The VCR light will disappear.)

3

Use the TV channel selector to **put the TV on the Cable Box/DSS Receiver output channel (channel 03 or 04).**

4

Select the channel you want to watch at the Cable Box/DSS Receiver.

Playing a Tape

1

Press the **VCR/TV** button to put the VCR in VCR position (the VCR light will appear on the display panel).

2

Make sure the Cable Box/DSS Receiver is on the same channel as the VCR's CH3/CH4 switch.

3

Use the TV channel selector to **put the TV on the same channel.**

4

Press the **PLAY** button to play the tape.

Helpful Hint

- You cannot record scrambled channels with this connection.

10 Hookups With a Stereo TV

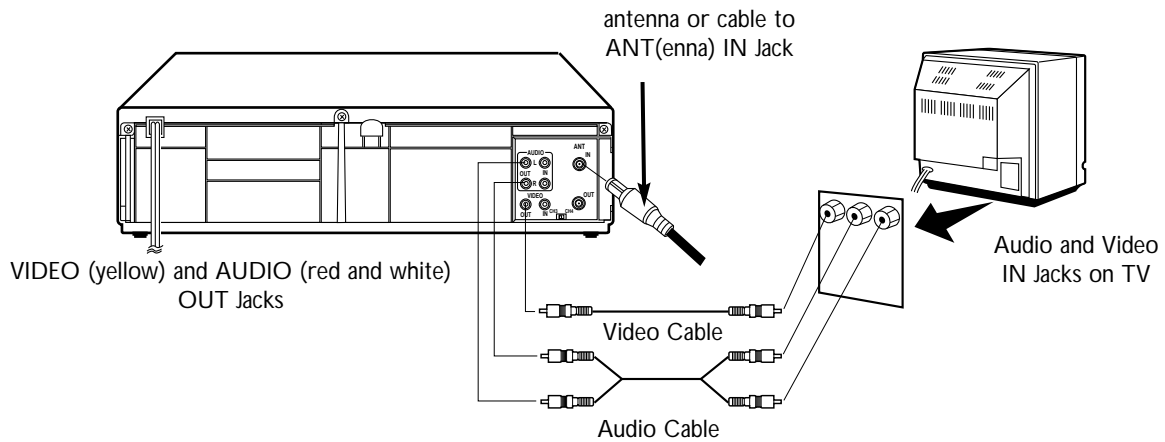

- Audio and Video cables are not supplied.

1

Connect the antenna or cable to the ANT(enna) IN Jack on the back of the VCR.

2

Connect a video cable to the yellow VIDEO OUT Jack on the back of the VCR. Then, connect the other end of the video cable to the VIDEO IN Jack on your TV.

3

Connect an audio cable to the red and white AUDIO OUT Jacks on the back of the VCR. Then, connect the other end of the audio cable to the AUDIO IN Jacks on your TV.

4

Turn on your TV, making sure it is in Line Input mode. Please refer to your TV owner's manual for details.

Helpful Hints

- A stereo audio cable (not supplied) is used here to deliver audio to the TV's left and right channels.
- The TV must be in Line Input mode. Please refer to your TV owner's manual.

Turning on Your VCR 11

Before turning on your VCR, make sure there are batteries in the remote control and the VCR and TV are connected correctly.

- Follow the steps on this page only when you plug the VCR power cord into the wall outlet for the first time.
- You may not be able to program channels at step 5 if you are using a Cable Box. In this case, press the Number 1 button at step 5. You can go to step 5 on page 38 to set up the VCR's internal Cable Box Controller.

1

Turn on the TV. Set it to the same channel as the CH3/CH4 switch on the back of the VCR.

2

Press the **VCR** button, then the **POWER** button. The VCR light will appear on the display panel and the language select display screen shown below will appear. (If the display does not appear, check your hookups, then follow the steps on page 12 to program channels and page 19 to select a language.)

TO SELECT PUSH NO. SHOWN
1 ENGLISH ON
2 ESPAÑOL

MAKE SELECTION OR
PUSH MENU TO CONTINUE

3

Press the **Number 1** button to select English on-screen displays. ON will appear to the right of ENGLISH on-screen. **Or**, press the **Number 2** button for Spanish on-screen displays. SI will appear to the right of ESPAÑOL on-screen.

4

Press the **MENU** button. The channel program display shown below will appear. The display will disappear after about 60 seconds if you do not press any buttons.

CABLE BOX USER : PRESS 1
OTHERS : CONNECT ANTENNA
OR CABLE TO VCR
THEN
PUSH CH UP KEY
OR
FOR PLAY ONLY - PUSH STOP

5

Press the **CH(annel) Up** button to begin automatic channel programming. AUTO SET PROCEEDING PLEASE WAIT will appear on-screen. The VCR will place all of the channels you receive into its memory, so when you scan through channels using the CH(annel) Up/Down buttons, you'll only scan through channels that you receive. When all channels are programmed, CHANNELS ARE SET will appear on-screen briefly. Then the TV will go to the lowest channel programmed.

1

 Turn on the TV.

2

4

3

5

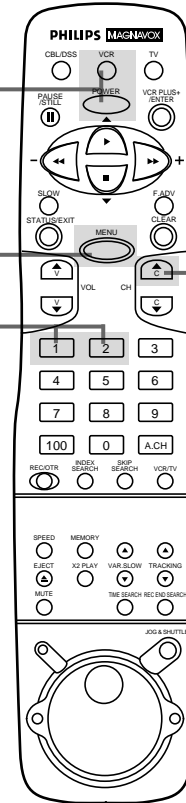

Helpful Hints

- To skip this feature and play a tape immediately, insert a tape with its record tab removed. Or, to skip step 3, press the MENU button. All on-screen displays will be in English. To skip step 5, press the STOP button. Channels will not be programmed, and CHANNELS NOT SET will appear on-screen.
- If you try to program channels when there is no antenna or cable connected to the VCR, programming will appear to take place, but eventually a NO TV SIGNALS message will appear on-screen. Connect an antenna or cable to the VCR's ANT(enna) IN Jack and try again. You may need to follow the steps on page 12.

12 Channel Memory

Programming Channels

Although your VCR may automatically memorize the channels you receive when you turn it on for the first time, this function lets you reprogram channels.

1

Press the VCR button.

2

Press the MENU button to bring up the main menu display.

TO SELECT PUSH NO. SHOWN

- 1 PROGRAM
- 2 VCR SET UP
- 3 TUNER SET UP
- 4 SET CLOCK
- 5 CABLE BOX CONTROLLER
- 6 REMOTE LOCATOR

TO END PUSH EXIT

3

Press the Number 3 button to select TUNER SET UP.

TO SELECT PUSH NO. SHOWN

- 1 TV
 - 2 CABLE TV
 - 3 AUTO PROGRAMMING ON
 - 4 ADD/DELETE CH
 - 5 CH MEMORY REVIEW
 - 6 TV STEREO ON
 - 7 2ND AUDIO
- TO END PUSH EXIT

4

Press the Number 1 button to select TV (if you have an antenna) or the Number 2 button to select CABLE TV (if you have a cable connection). ON will appear to the right of your choice.

5

Press the Number 3 button to select AUTO PROGRAMMING. MEMORIZED CHANNEL / PLEASE WAIT will appear on-screen. The VCR will place all the channels you receive into its memory.

6

Wait for a few minutes while the VCR programs channels. When programming is complete, CHANNELS ARE SET will appear on-screen. Then the programming of the lowest channel number placed in the VCR's memory will appear on-screen. Now when you press the CH(annel) Up/Down buttons, you will scan only through channels you receive.

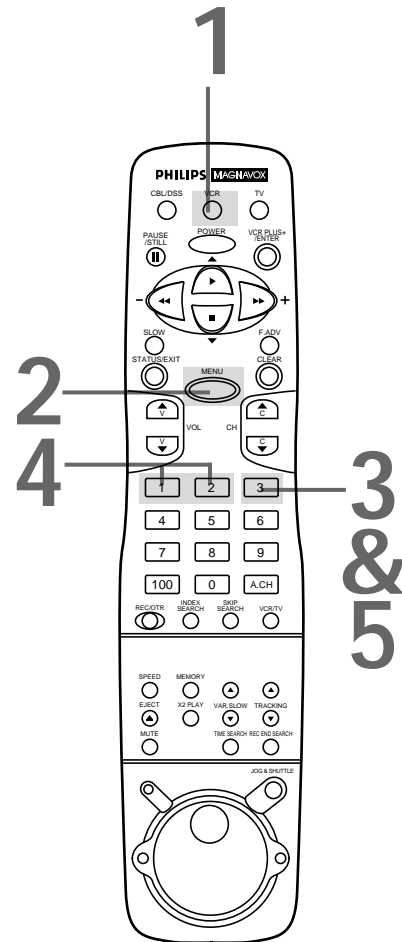

Helpful Hints

- You can not enter the TUNER SET UP menu when you are in Line Input mode.
- Line Input mode will always be stored in the VCR's memory as channel 001 or 002. When you select channel 001 or 002 with the CH(annel) Up/Down buttons or the Number buttons, AV REAR or AV FRONT will appear on the screen briefly.
- You may not be able to program channels if you are using a Cable Box. See pages eight-nine for details.
- To switch between TV and CABLE TV selection, repeat the steps on this page.

Adding/Deleting Channels

1

Press the VCR button.

2

Press the MENU button to bring up the main menu display.

3

Press the Number 3 button to select TUNER SET UP.

4

Press the Number 4 button to select ADD/DELETE CH.

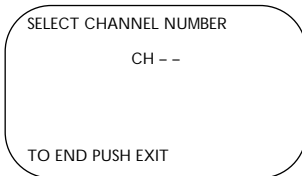

5

Use the Number buttons to enter the channel number.

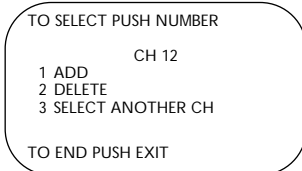

6

Press the Number 1 button to add that channel or the Number 2 button to delete that channel. Or, press the Number 3 button to leave that channel unchanged and select another channel. If you do not make a choice within five seconds, you will return to the previous menu display.

7

Press the STATUS/EXIT button to exit.

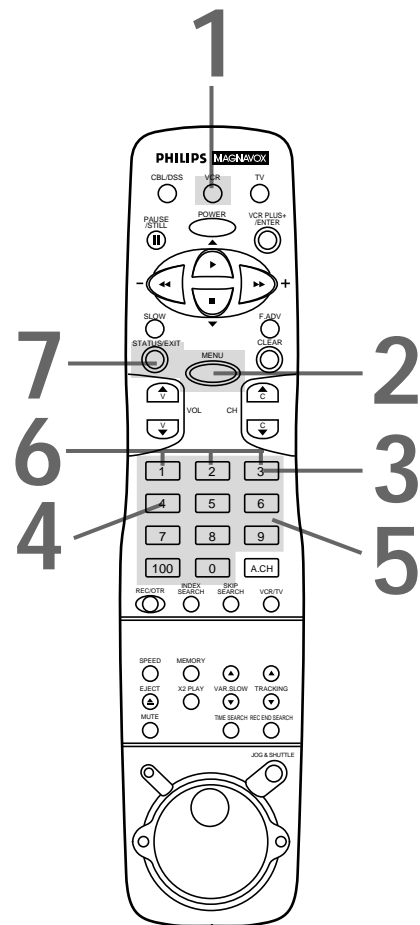

Reviewing Programmed Channels

1. Press the VCR button.
2. Press the MENU button to bring up the main menu display.
3. Press the Number 3 button to select TUNER SET UP.
4. Press the Number 5 button to select CH MEMORY REVIEW. A list of programmed channels will appear on-screen.
 - If all the programmed channels don't fit on the screen, press the Number 1 button to see the remaining channels. Then press the Number 2 button to return to the first screen of channels.
 - If you do not press any buttons within 10 seconds, you will either go to the next screen of channels or return to the previous menu display.
5. Press the STATUS/EXIT button once or twice to exit.

14 Setting the Clock

There are two ways to set the clock. With manual clock setting, you tell the VCR the current time. With automatic clock setting, the VCR gets the current time from your local PBS station. It keeps track of the time by constantly referring to the time broadcasted by your PBS station.

If you are using a Cable Box or Digital Satellite System, you must set the clock manually.

Follow the instructions under either manual clock setting or automatic clock setting (page 16) to set the VCR's clock. Before you begin, make sure:

- The VCR is hooked up and turned on, and channels are programmed into the VCR's memory (see pages six - 12).
- The VCR is in VCR position. (The VCR light will appear on the display panel. If it does not, press the VCR/TV button once.)
- You make each entry within 60 seconds of the previous entry. (If you do not, you may start again at step 1.)

Manual Clock Setting

1

Press the VCR button.

2

Press the MENU button to bring up the main menu display.

TO SELECT PUSH NO. SHOWN
 1 PROGRAM
 2 VCR SET UP
 3 TUNER SET UP
 4 SET CLOCK
 5 CABLE BOX CONTROLLER
 6 REMOTE LOCATOR

TO END PUSH EXIT

3

Press the Number 4 button to select SET CLOCK.

SET CLOCK
 1 AUTO CLOCK [ON]
 2 SET MANUAL CLOCK [ON]
 3 DAYLIGHT SVG TIME [ON]
 4 SET TIME ZONE (AUTO)
 CABLE BOX USERS
 SET CLOCK MANUALLY
 TO SELECT PUSH NO. SHOWN
 TO END PUSH EXIT

4

Press the Number 2 button to select SET MANUAL CLOCK.

TIME --:--
 DATE --/--/--

TO END PUSH EXIT

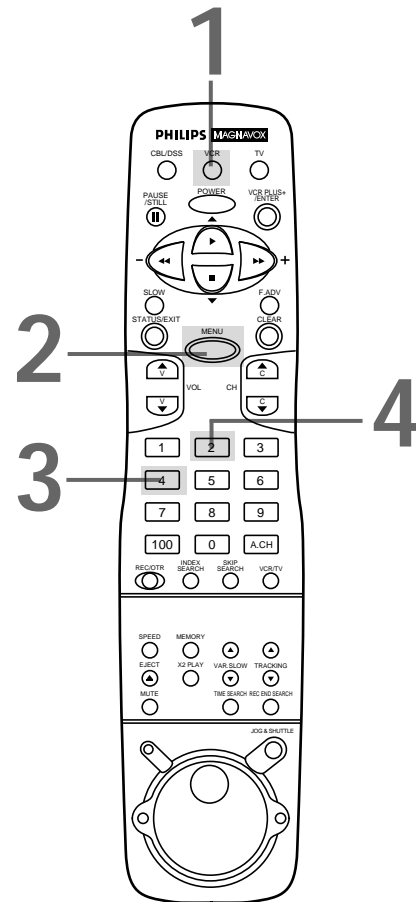

Helpful Hints

- To display the time, press the STATUS/EXIT button. A status display, which includes the time, will appear on the TV screen for about five seconds. For details, see "On-Screen Status Displays" on page 26.
- If you press the STATUS/EXIT button while you are setting the clock, the TV screen will return to the program you were watching. If this happens, start over.
- Power failures that last for more than one hour can cause you to lose your clock setting if you set the clock manually. If this happens, reset the clock.

Setting the Clock (cont'd) 15

5

Press two Number buttons for the hour(s) and two Number buttons for the minute(s). Then press 1 for AM or 2 for PM. For example, for 2:15 PM, press 02, 15, 2.

- Enter a 0 before a single digit number.
- Entries that do not match the VCR's internal calendar will cause a question mark (?) to appear on-screen.
- To make corrections, press the CLEAR button until the space for the number you want to correct is flashing. Then enter the correct number.

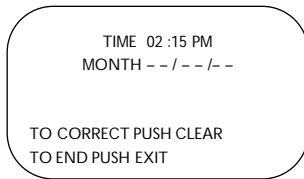

6

Press two Number buttons for the month, two Number buttons for the day, and two Number buttons for the year. For example, for July 1, 1997, press 07, 01, 97. The day of the week will appear automatically.

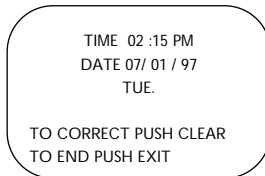

7

Press the STATUS/EXIT button to start the clock. The screen will return to the program you were watching. The time will appear on the VCR display panel.

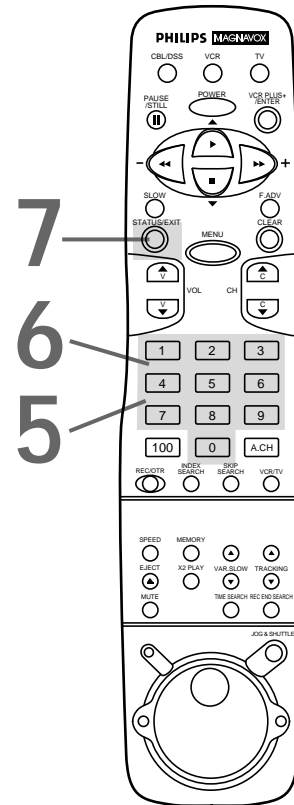

16 Setting the Clock (cont'd)

Automatic Clock Setting

1

Press the VCR button, then press the MENU button to bring up the main menu display.

TO SELECT PUSH NO. SHOWN

- 1 PROGRAM
- 2 VCR SET UP
- 3 TUNER SET UP
- 4 SET CLOCK
- 5 CABLE BOX CONTROLLER
- 6 REMOTE LOCATOR

TO END PUSH EXIT

2

Press the Number 4 button to select SET CLOCK.

- SET CLOCK
- 1 AUTO CLOCK [ON]
 - 2 SET MANUAL CLOCK
 - 3 DAYLIGHT SVG TIME [ON]
 - 4 SET TIME ZONE (AUTO)
- CABLE BOX USERS
SET CLOCK MANUALLY
TO SELECT PUSH NO. SHOWN
TO END PUSH EXIT

3

If OFF appears to the right of AUTO CLOCK, press the Number 1 button once. A new display screen will appear. Go to step 4. Or, if ON appears to the right of AUTO CLOCK, press the Number 1 button twice. A new display screen will appear. Go to step 4.

4

- If you want the VCR to locate a local PBS station from which to take the time, press the Number 1 button to select SET PBS CH. AUTO. When the current time appears on-screen, you're finished. Press the STATUS/EXIT button to exit. Or, you may be prompted to turn off the VCR. Press the STATUS/EXIT button, then go to step 5.

NOTE: CANNOT FIND PBS CLOCK DATA may flash on-screen. In this case, tell the VCR the PBS station from which to take the time.

- If you want to tell the VCR the PBS station from which to take the time, press the Number 2 button to select SET PBS CH. MANUAL, then use the Number buttons to enter the channel number of the desired PBS station. When the current time appears on-screen, you're finished. Press the STATUS/EXIT button to exit.

NOTE: CANNOT FIND PBS CLOCK DATA may flash on-screen. In this case, press the Number 1 button to choose SELECT NEW PBS CH., then use the Number buttons to enter the channel number of another PBS station. Or, press the Number 2 button to select SET PBS CH. AUTO. Press the STATUS/EXIT button, then go to step 5.

5

Turn off the VCR power, and leave it off for several minutes. When the current time appears on the VCR display panel, the clock is set. You may turn on the VCR again.

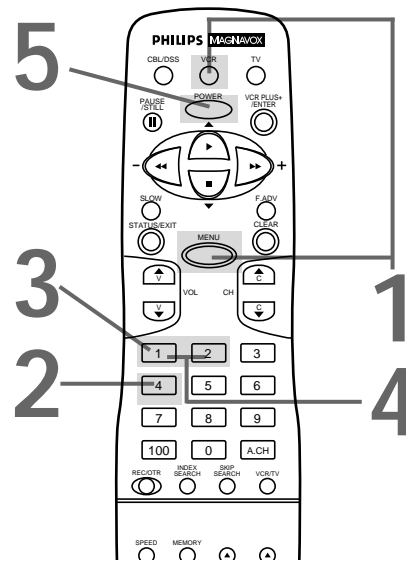

Helpful Hints

For Automatic Clock Setting

- If you enter an incorrect PBS channel number at step 4, press the CLEAR button, then enter the correct channel number.
- If you have an antenna, you may select channels 2 - 69 at step 4. If you have a cable connection, you may select channels 1 - 125.
- If you select SET PBS CH. AUTO at step 4, you cannot manually select the PBS channel from which you want the VCR to take the time.
- The clock cannot be set automatically if you don't receive a channel that carries a time signal in your area. Set the clock manually.
- If there are only a few channels in your area that carry time signals, setting the clock automatically may take several minutes. If nothing happens even after you wait several minutes, set the clock manually.
- You cannot select AUTO CLOCK at step 3 during tape playback.
- The clock cannot be set automatically if CABLE BOX CONTROLLER is set to ON. (See pages 38 - 39.) You must set the clock manually. If you set AUTO CLOCK to ON at step 3 when CABLE BOX CONTROLLER is ON, CABLE BOX USERS SET CLOCK MANUALLY flashes on-screen for about five seconds, then the manual clock setting menu appears. Follow steps 5-7 on page 15.

Setting the Clock (cont'd) 17

Time Zone

When using the AUTO CLOCK function, you can specify a time zone in which a local PBS channel is located. That way, the VCR will update the clock according to your time zone.

1

Press the **VCR** button, then press the **MENU** button to bring up the main menu display.

TO SELECT PUSH NO. SHOWN

- 1 PROGRAM
- 2 VCR SET UP
- 3 TUNER SET UP
- 4 SET CLOCK
- 5 CABLE BOX CONTROLLER
- 6 REMOTE LOCATOR

TO END PUSH EXIT

2

Press the **Number 4** button to select SET CLOCK.

SET CLOCK [ON]
 1 AUTO CLOCK [ON]
 2 SET MANUAL CLOCK [ON]
 3 DAYLIGHT SVG TIME [ON]
 4 SET TIME ZONE (AUTO)
 CABLE BOX USERS
 SET CLOCK MANUALLY
 TO SELECT PUSH NO. SHOWN
 TO END PUSH EXIT

3

Press the **Number 4** button to select SET TIME ZONE.

TO SELECT PUSH NO. SHOWN
 1 AUTO ON
 2 ATLANTIC
 3 EASTERN
 4 CENTRAL
 5 MOUNTAIN
 6 PACIFIC
 7 ALASKA
 8 HAWAII
 TO CONTINUE PUSH MENU

4

Find your time zone, then press the **Number** button to select it. You will return to the previous menu. The time zone you selected will appear beneath SET TIME ZONE.

SET CLOCK [ON]
 1 AUTO CLOCK [ON]
 2 SET MANUAL CLOCK [ON]
 3 DAYLIGHT SVG TIME [ON]
 4 SET TIME ZONE (ATLANTIC)
 CABLE BOX USERS
 SET CLOCK MANUALLY
 TO SELECT PUSH NO. SHOWN
 TO END PUSH EXIT

5

Press the **STATUS/EXIT** button to exit. Or, to set the clock, go to step 6.

6

Press the **Number 1** button to select AUTO CLOCK. (See page 16 for details.)

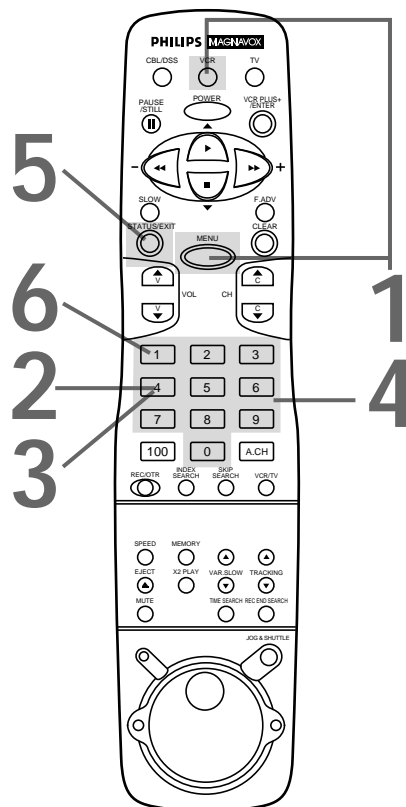

18 Daylight-Saving Time Selection

Daylight-Saving Time Selection

You may program the VCR so its clock will automatically move forward one hour in April and turn back one hour in October. Daylight-Saving Time is set to ON prior to shipment from the factory.

You may turn Daylight-Saving Time ON or OFF by following the steps below.

1

Press the VCR button.

2

With the clock set, press the MENU button to bring up the main menu display.

TO SELECT PUSH NO. SHOWN

- 1 PROGRAM
- 2 VCR SET UP
- 3 TUNER SET UP
- 4 SET CLOCK
- 5 CABLE BOX CONTROLLER
- 6 REMOTE LOCATOR

TO END PUSH EXIT

3

Press the Number 4 button to select SET CLOCK.

SET CLOCK

- 1 AUTO CLOCK [ON]
 - 2 SET MANUAL CLOCK
 - 3 DAYLIGHT SVG TIME [ON]
 - 4 SET TIME ZONE (AUTO)
- CABLE BOX USERS
SET CLOCK MANUALLY
TO SELECT PUSH NO. SHOWN
TO END PUSH EXIT

4

Press the Number 3 button so that OFF (or ON) appears to the right of DAYLIGHT SVG TIME.

SET CLOCK

- 1 AUTO CLOCK [ON]
 - 2 SET MANUAL CLOCK
 - 3 DAYLIGHT SVG TIME [OFF]
 - 4 SET TIME ZONE (AUTO)
- CABLE BOX USERS
SET CLOCK MANUALLY
TO SELECT PUSH NO. SHOWN
TO END PUSH EXIT

5

Press the STATUS/EXIT button to exit.

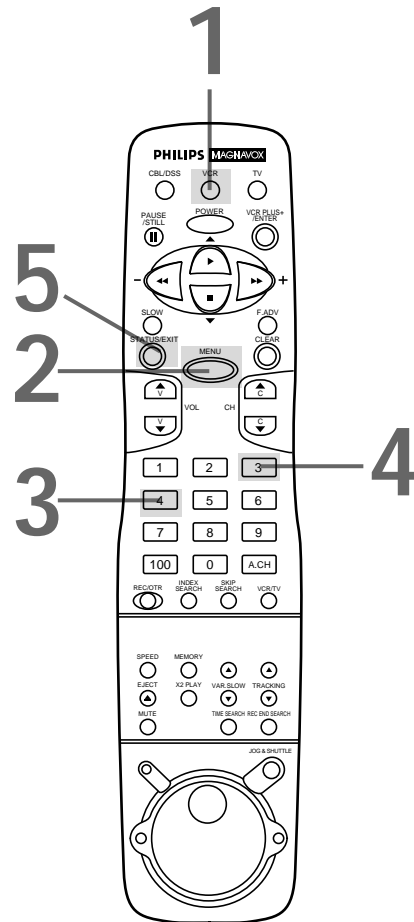

Language Selection 19

Language Selection

Follow the steps below to change the language of the on-screen displays.

1

Press the VCR button.

2

Press the MENU button to bring up the main menu display.

TO SELECT PUSH NO. SHOWN

- 1 PROGRAM
- 2 VCR SET UP
- 3 TUNER SET UP
- 4 SET CLOCK
- 5 CABLE BOX CONTROLLER
- 6 REMOTE LOCATOR

TO END PUSH EXIT

3

Press the Number 2 button to select VCR SET UP.

TO SELECT PUSH NO. SHOWN

- 1 REPEAT PLAY OFF
- 2 ON SCREEN MODE
- 3 AUDIO OUT
- 4 LANGUAGE
- 5 VCR PLUS+ REF. MAP

TO END PUSH EXIT

4

Press the Number 4 button to select LANGUAGE.

TO SELECT PUSH NO. SHOWN

- 1 ENGLISH ON
- 2 ESPAÑOL

MAKE SELECTION OR
PUSH MENU TO CONTINUE

5

Press the Number 1 button if you want the on-screen displays in English. ON will appear to the right of ENGLISH on-screen. **Or**, press the Number 2 button if you want the on-screen displays in Spanish. SI will appear to the right of ESPAÑOL on-screen.

6

Press the MENU button to exit.

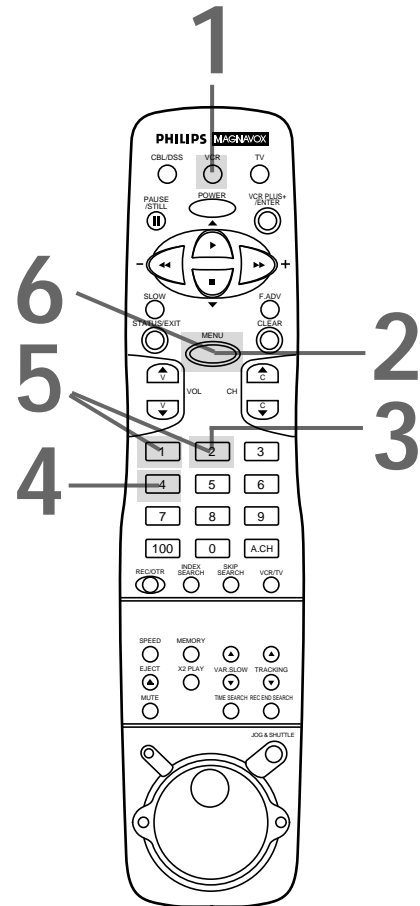

Helpful Hint

• If you accidentally select Spanish on-screen displays and need English on-screen displays:

1. Press the VCR button.
2. Press the MENU button.
3. Press the Number 2 button to select PREPARE LA VCR.
4. Press the Number 4 button to select LENGUAJE.
5. Press the Number 1 button to select ENGLISH.
6. Press the MENU button to exit.

20 Setting the Remote to Operate a TV

Your VCR remote control **may** operate your TV. If the remote control doesn't operate your TV now, follow the steps below to program your remote control.

1

Point the remote control at your TV and **press the TV button**. Then, **press the POWER button**. If your TV turns on or off, try the other TV buttons (see pages 23 - 25). If your TV doesn't turn on or off, or if the other buttons don't work, go to step 2.

2

Find the brand of your TV on the list below, and remember the two-digit number to the right of it.

TV CODES			
EMERSON14	PHILCO14
FISHER11	PHILIPS01
GE10	PHILIPS MAGNAVOX. .	.01, .02, .03
GOLDSTAR04	QUASAR07
HITACHI12	RCA10
JVC05	SAMSUNG17
MAGNAVOX01, .02, .03	SANYO11
MARANTZ13	SEARS08, .11
mitsubishi13	SHARP16
MONTGOMERY WARD14	SONY09
PANASONIC07	TOSHIBA08
PANASONIC-GA0007	ZENITH06, .15

3

Press and release the MUTE button.

4

Within 30 seconds after releasing the MUTE button, **press and release the TV button**.

5

Within 30 seconds after releasing the TV button, **use the Number buttons to enter the two-digit code for your TV brand**. For example, if you have a Zenith TV, press Number buttons 1, 5.

6

Try step 1 again. If the remote control works your TV, you're finished. If the remote control still doesn't work your TV, repeat steps 2 - 5, using another code.

There is no guarantee that the remote will work your TV.

2

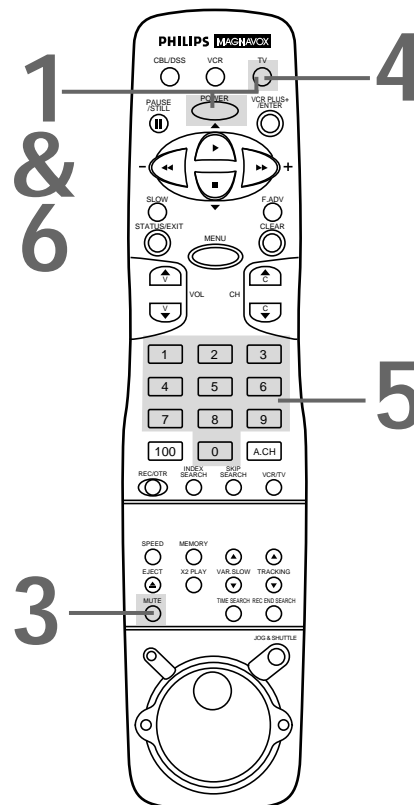
 Find your TV code.

Helpful Hints

- Although the remote control that comes with your VCR will work most Magnavox TVs, as well as many TVs sold under other brand names, it is possible that the remote control will not operate your TV.
- The remote control may only operate some features of your TV. For example, the remote control may turn on the TV power, but it may not change channels at the TV.
- If you can not change the channels at the TV by using the Number buttons, press the VCR PLUS+/ENTER button after you press the Number buttons. It may change channels at the TV.
- If you had to program the remote control to operate your TV here, whenever you replace the batteries in the remote control, you will have to program the remote control again.

Setting the Remote to Operate a Cable Box/Digital Satellite System 21

Your VCR remote control **may** operate your Cable Box or Digital Satellite System. If the remote control doesn't operate your Cable Box or Satellite System now, follow the steps below to program your remote control.

1

Point the remote control at your Cable Box or Satellite System and **press the CBL/DSS button. Then, press the POWER button.** If your Cable Box or Satellite System turns on or off, try the other Cable Box/Satellite System buttons (see pages 23 - 25). If your Cable Box or Satellite System doesn't turn on or off, or if the other buttons don't work, go to step 2.

2

Find the brand of your Cable Box or Satellite System on the list below, and remember the two-digit number to the right of it.

CABLE BOX CODES	
HAMLIN21, 22	PIONEER11, 12
JERROLD01, 02, 03,04, 05, 06, 07	SCIENTIFIC
OAK16, 17, 18	ATLANTA08, 09, 10
PANASONIC19, 20	TOCOM23, 24, 25
	ZENITH13, 14, 15

SATELLITE SYSTEM CODES	
MAGNAVOX26, 27	RCA28

3

Press and release the MUTE button.

4

Within 30 seconds after releasing the MUTE button, **press and release the CBL/DSS button.**

5

Within 30 seconds after releasing the CBL/DSS button, **use the Number buttons to enter the two-digit code for your Cable Box or Satellite System.** For example, if you have a Zenith Cable Box, press Number buttons 1, 3.

6

Try step 1 again. If the remote control works your Cable Box or Satellite System, you're finished. If the remote control still doesn't work your Cable Box or Satellite System, repeat steps 2 - 5, using a different code.

There is no guarantee that the remote control will work your Cable Box or Satellite System.

2

Find your Cable Box/Satellite System code.

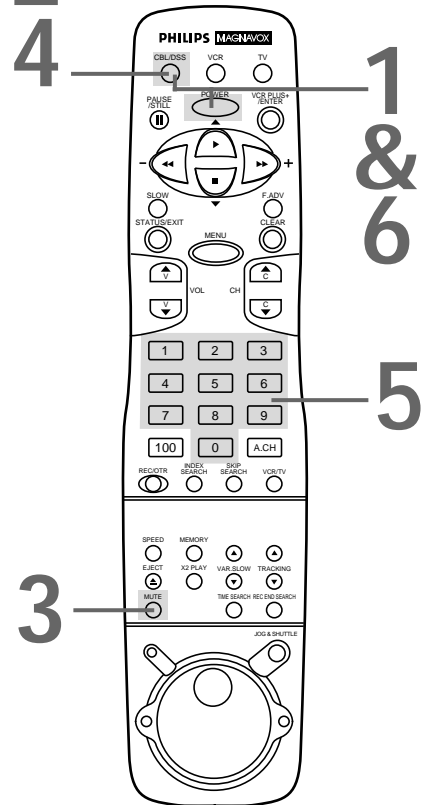

Helpful Hints

- Although the remote control that comes with your VCR will work most Cable Boxes and Satellite Systems, it is possible that the remote control will not operate your Cable Box or Satellite System.
- The remote control may only operate some features of your Cable Box or Satellite System. For example, some Cable Boxes may only be turned on at the Cable Box, therefore the remote control will not be able to turn on the Cable Box.
- If you can not change the channels at the Cable Box by using the Number buttons, press the VCR PLUS+/ENTER button after you press the Number buttons. It may change channels at the Cable Box.
- If you had to program the remote control to operate your Cable Box or Satellite System here, whenever you replace the batteries in the remote control, you will have to program the remote control again.

22 Remote Locator

Letting your VCR find your remote for you...

1

Press the **POWER** button on the **VCR** to turn on the VCR. Your remote control beeps and **LOCATING REMOTE** appears on-screen. The remote control will beep for about 30 seconds. (The exception is when you plug the VCR power cord into the wall outlet for the first time.) Or, press any button on the remote control to stop the beeping.

If another remote control beeps...

The VCR may find other remote controls. If this occurs, follow the steps below to program the VCR to find only its remote control.

1

Press the **VCR** button, then press the **MENU** button.

2

Press the **Number 6** button to select **REMOTE LOCATOR**.

PRESS MUTE THEN
PAUSE KEY
TO CHANGE CODE FROM 4

TO END PUSH EXIT

3

Press the **MUTE** button, then the **PAUSE/STILL** button.

YOUR REMOTE LOCATOR
CODE IS 4

PRESS ANY DIGIT
TO CHANGE CODE

TO END PUSH EXIT

4

Press one **Number** button (**0 - 9**) to enter a new single-digit code for your remote control. Your remote control will beep briefly.

YOUR REMOTE LOCATOR
CODE HAS BEEN CHANGED

NEW CODE IS 3

TO END PUSH EXIT

5

Press the **STATUS/EXIT** button to exit.

If another remote control beeps...

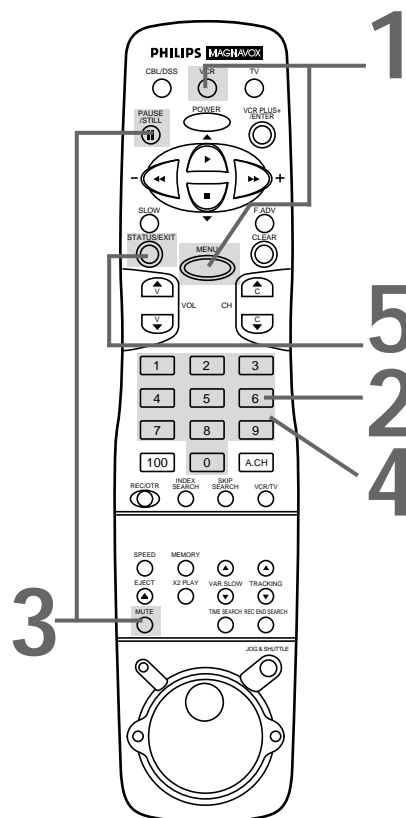

Remote Control Buttons 23

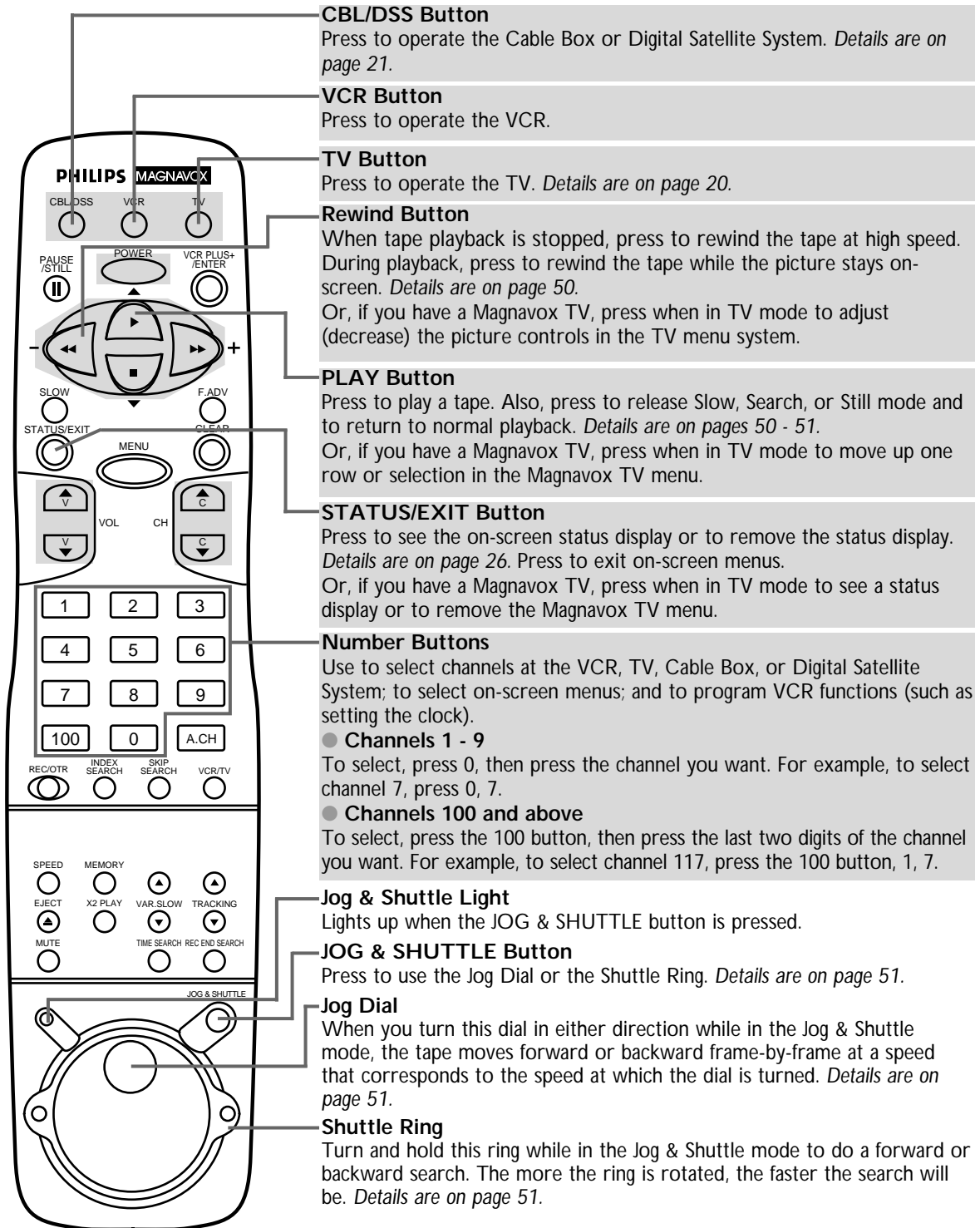

Helpful Hints

- Press the VCR button before pressing other VCR buttons; press the TV button before pressing other TV buttons; press the CBL/DSS button before pressing other Cable Box/Satellite System buttons.
- The buttons with a shaded description may also operate features of your TV, Cable Box, or Satellite System.
- Buttons that are shaded in the illustration light up for five seconds when you press one of them.

24 Remote Control Buttons (cont'd)

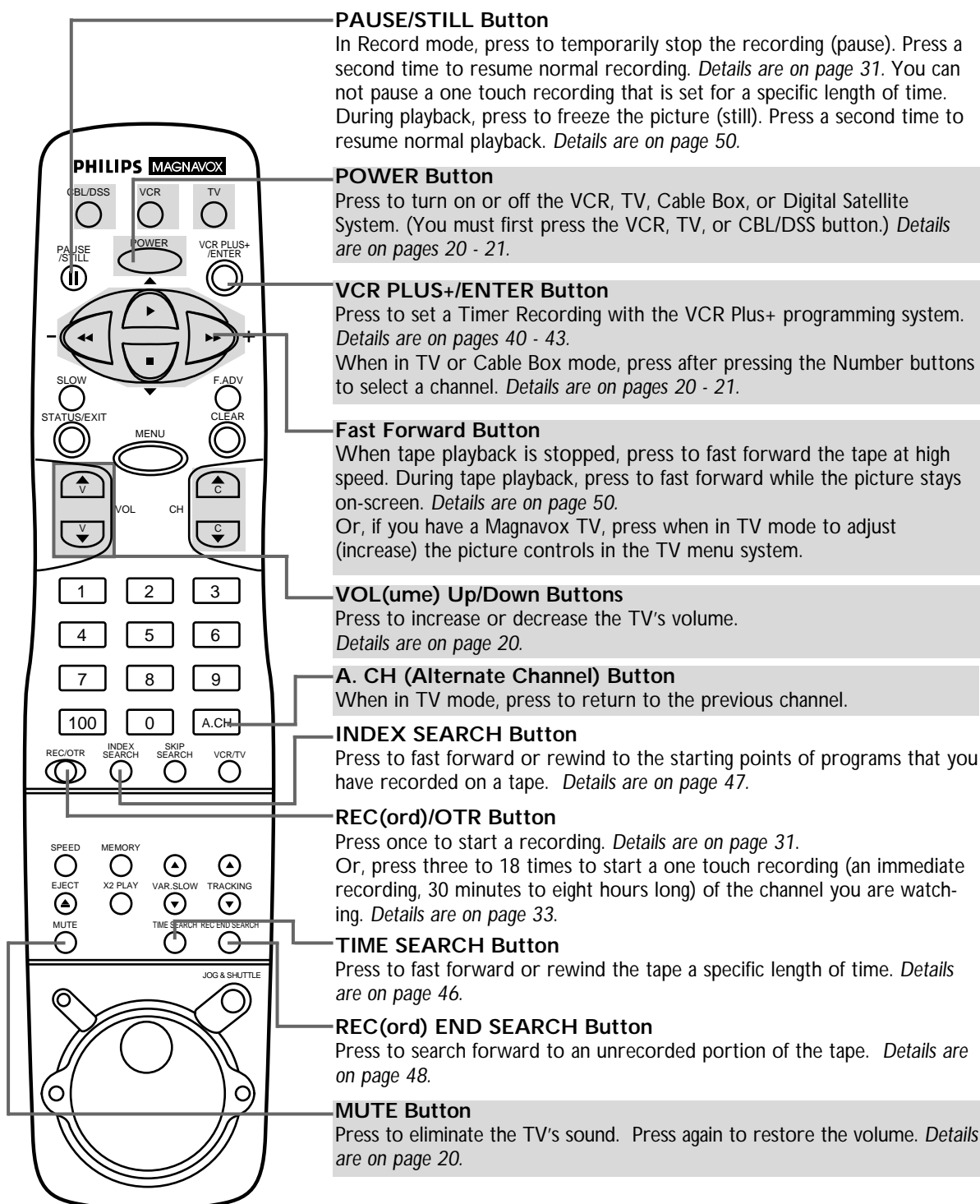

Helpful Hints

- Press the VCR button before pressing other VCR buttons; press the TV button before pressing other TV buttons; press the CBL/DSS button before pressing other Cable Box/Satellite System buttons.
- The buttons with a shaded description may also operate features of your TV, Cable Box, or Satellite System.
- Buttons that are shaded in the illustration light up for five seconds when you press one of them.

Remote Control Buttons (cont'd) 25

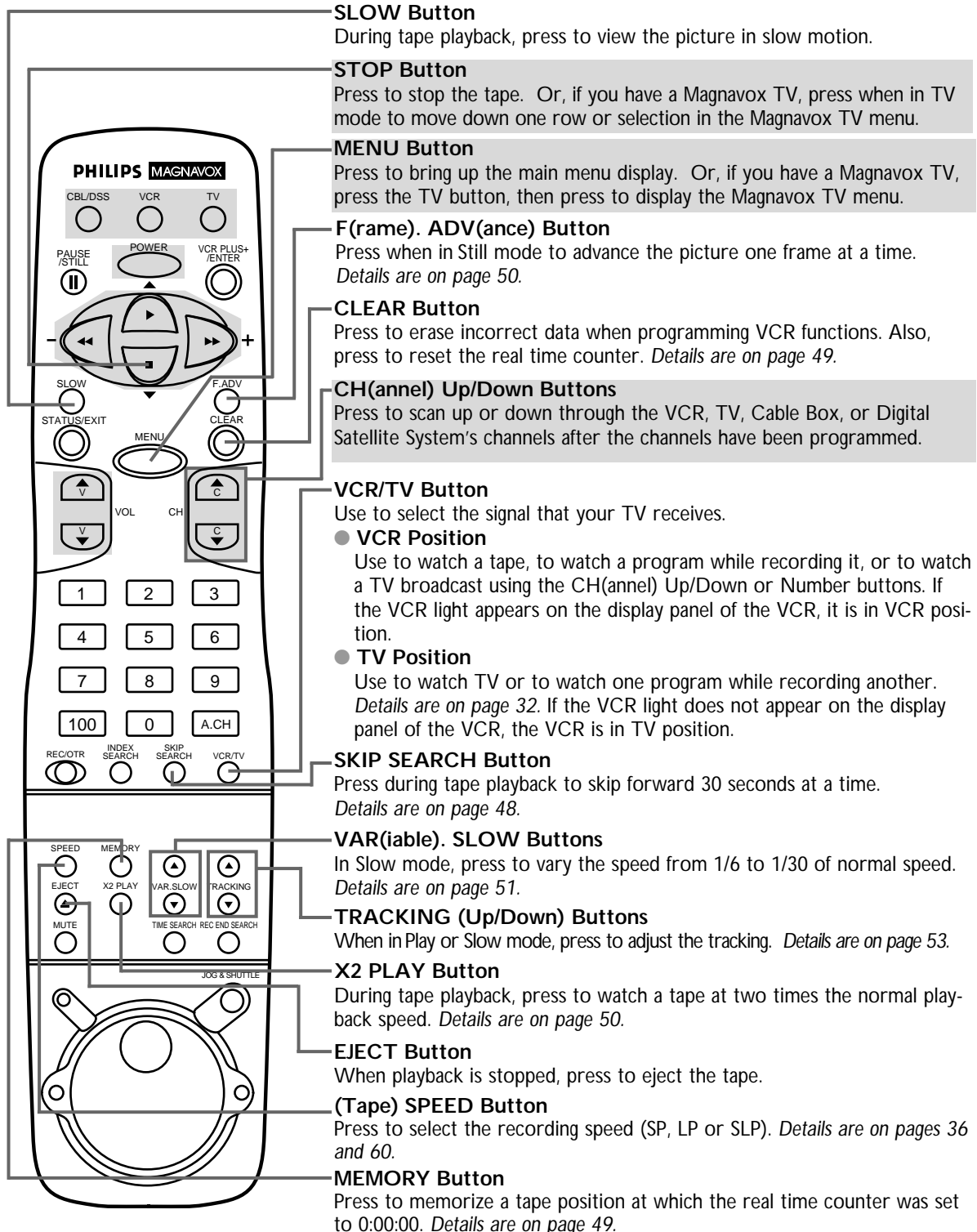

Helpful Hints

- Press the VCR button before pressing other VCR buttons; press the TV button before pressing other TV buttons; press the CBL/DSS button before pressing other Cable Box/Satellite System buttons.
- The buttons with a shaded description may also operate features of your TV, Cable Box, or Satellite System.
- Buttons that are shaded in the illustration light up for five seconds when you press one of them.

26 On-Screen Status Displays

A status display, which includes the current time, channel, and other information (see illustration), will appear when you press the STATUS/EXIT button or certain function buttons. The contents of the status display may vary. There are three status display modes:

ON SCREEN ON:

- Whenever you press the STOP button or the PLAY button, the status display will appear for five seconds.

COUNTER ONLY:

- Whenever you press the STOP button or the PLAY button, the status display will appear for five seconds. After five seconds, only the counter will remain on-screen. You must press the STATUS/EXIT button to remove it.

ON SCREEN OFF:

- The status display will not appear when you press function buttons. You must press the STATUS/EXIT button to see the status display. To choose the status display mode, follow the steps below.

1

Press the VCR button, then press the MENU button to bring up the main menu display.

TO SELECT PUSH NO. SHOWN
 1 PROGRAM
 2 VCR SET UP
 3 TUNER SET UP
 4 SET CLOCK
 5 CABLE BOX CONTROLLER
 6 REMOTE LOCATOR

TO END PUSH EXIT

2

Press the Number 2 button to select VCR SET UP.

TO SELECT PUSH NO. SHOWN
 1 REPEAT PLAY OFF
 2 ON SCREEN MODE
 3 AUDIO OUT
 4 LANGUAGE
 5 VCR PLUS+ REF. MAP

TO END PUSH EXIT

3

Press the Number 2 button to select ON SCREEN MODE.

TO SELECT PUSH NO. SHOWN
 1 ON SCREEN ON ON
 2 COUNTER ONLY
 3 ON SCREEN OFF

TO END PUSH EXIT

4

Press the Number 1 button to select ON SCREEN ON, the Number 2 button to select COUNTER ONLY, or the Number 3 button to select ON SCREEN OFF. ON will appear beside the selected status display mode.

5

Press the STATUS/EXIT button to exit.

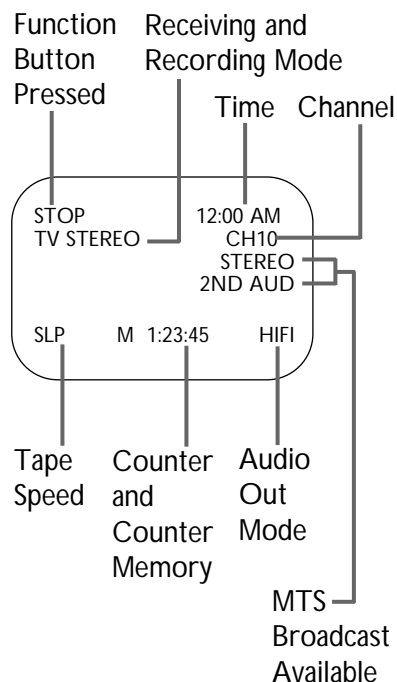

Helpful Hints

- If the channel you select has no broadcast, the screen will become solid blue. The screen will remain blue until you select an active channel.
- You may bring up the status display at any time by pressing the STATUS/EXIT button. (The exception is when viewing a still picture or a slow motion picture, or when Fast Forward or Rewind is pressed during playback.)
- Channel numbers (when tuned) are displayed for a few seconds.

VCR Display Panel 27

VCR Display Panel

Information about VCR operations appears here.

Cassette Compartment

Insert a tape here.

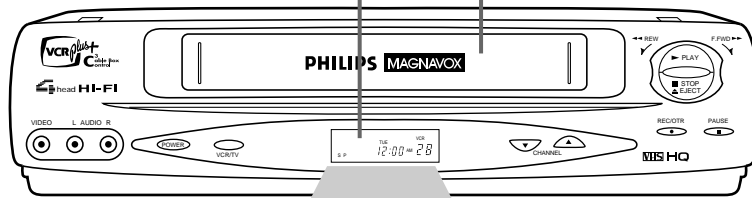

Cassette-Inside Light

This light indicates a tape is in the VCR.

Feature Lights

The current operation of the VCR appears here. See "Feature Light Symbols" below.

Timer Light

This light glows when you turn off the VCR if a timer recording is set. It also glows during a one touch recording. It flashes when you turn off the VCR if a timer recording has been set but a tape has not been placed in the VCR. It also flashes when a timer recording has finished (unless another timer recording is programmed, in which case it glows).

Day Display

The day appears here when the clock is set.

VCR Light

This light appears when the VCR is in VCR position.

Repeat Light

This light appears during Repeat Playback. Details are on page 45.

Speed Light

"SP" "LP" "SLP"
The tape speed appears here. Details are on pages 36 and 60.

Memory Light "M"

This light appears when a Real Time Counter Memory is set. Details are on page 49.



Digital Tracking Light

This light appears during tape playback to indicate Automatic Tracking Adjustment.

Clock Display

The current time appears here when the clock is set.

Channel/Line Input Display

The channel number appears here when a channel is selected. When L1 or L2 appears here, the VCR is in Line Input mode. (Line Input mode will always be stored in the VCR's memory as channel 001 or 002. Details are on page 60.)

Feature Light Symbols

These symbols appear on the display panel to indicate the current operation of the VCR.

	Play		Recording is paused
	Reverse Play (when using the Shuttle Ring)		Still Picture
	Rewind/Reverse Searching		Tape Eject
	Fast Forward/Fast Forward Searching X2 Play		Slow Motion/Frame Advance (when using the Jog Dial)
	Recording		Reverse Slow Motion/Reverse Frame Advance (when using the Jog Dial)

28 Front Panel

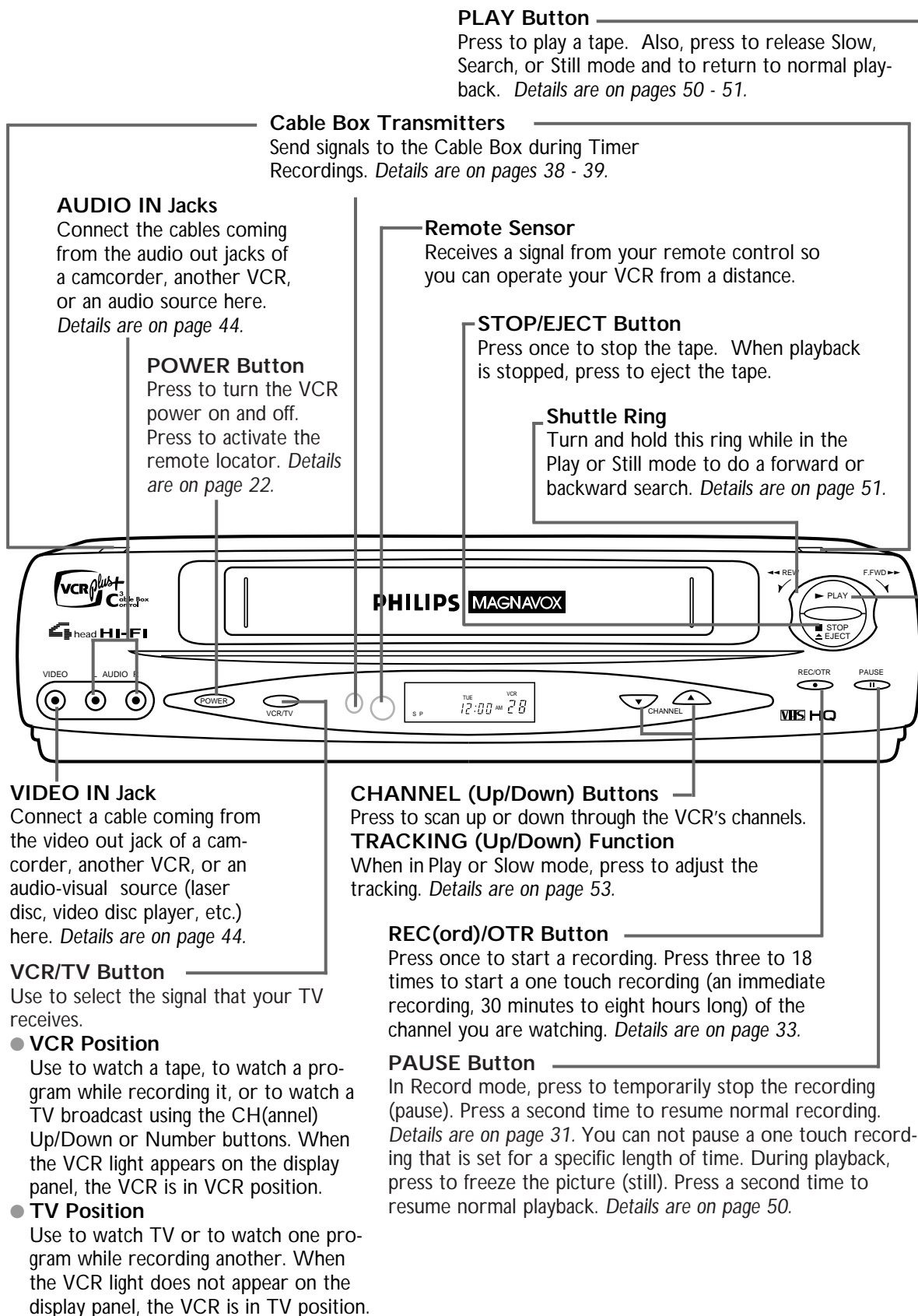

Rear Panel 29

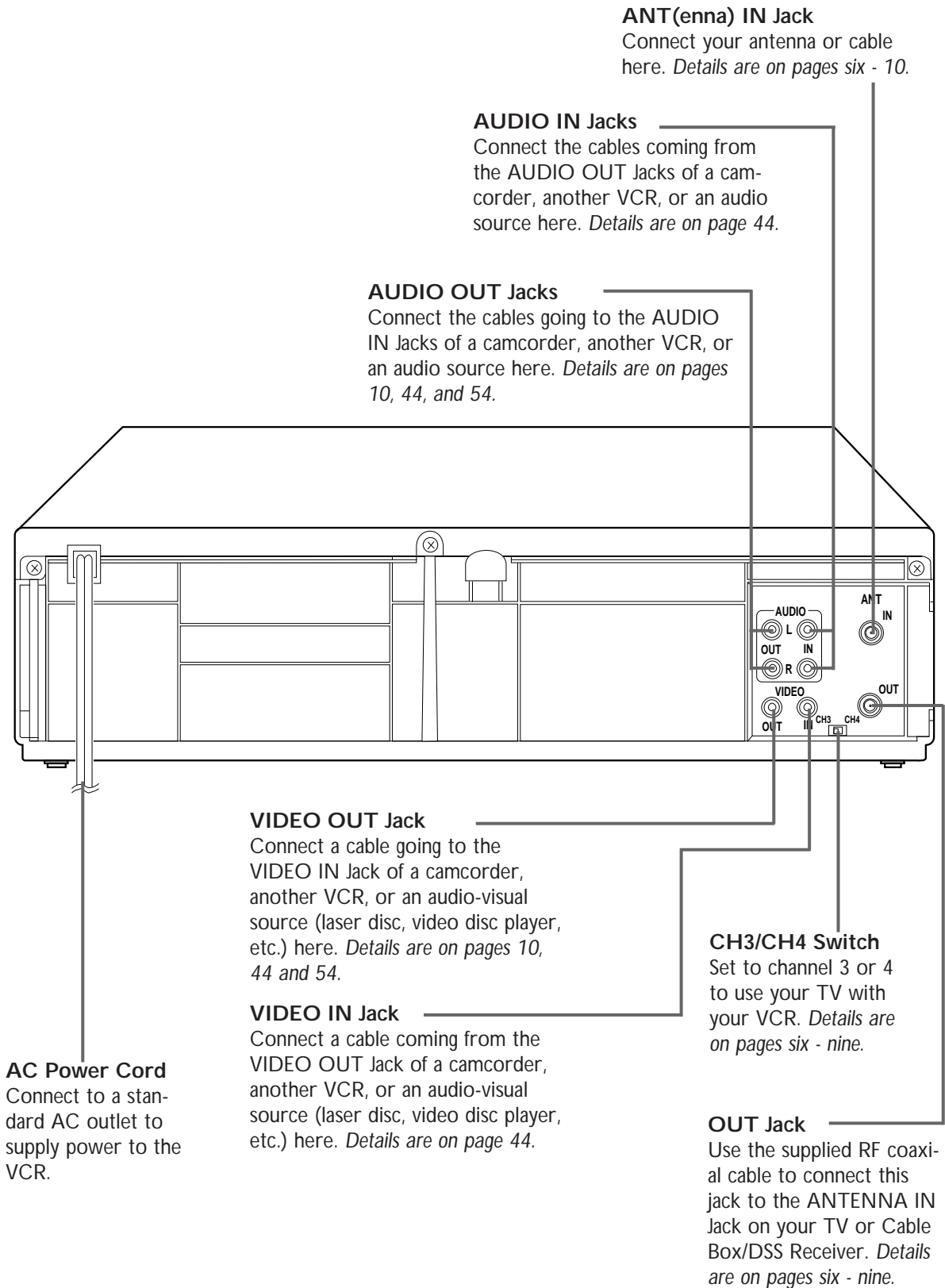

30 Playing

Read and follow the steps below to play a tape.

1

Turn on the TV and set it to channel 3 or 4, whichever the CH3/CH4 switch on the back of the VCR is set to.

2

Insert a tape in the VCR. The power will come on. The VCR will place itself in VCR position automatically (the VCR light and the Cassette-Inside light on the display panel of the VCR will appear). If the tape's record tab has been removed, playback will start automatically.

3

If playback does not start automatically, **press the PLAY button** to start playback.

4

Press the STOP button to stop playback.

5

Press the Rewind button to rewind the tape.

6

When the tape stops, press the EJECT button on the remote control or **the STOP/EJECT button on the VCR** to remove the tape.

1 Turn on the TV.

2 Insert a tape in the VCR.

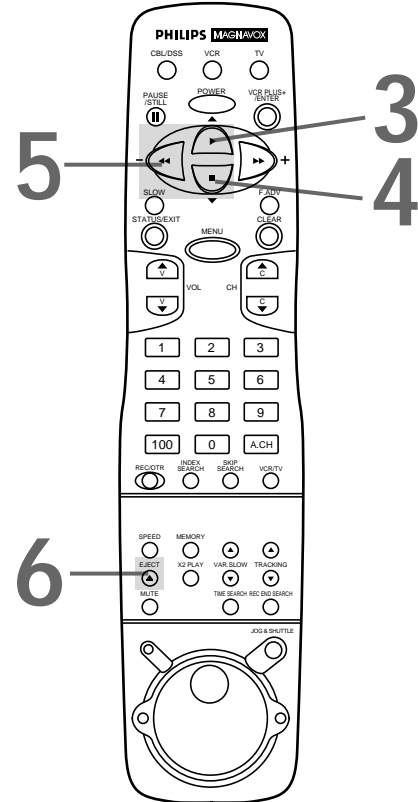

Helpful Hints

- If the tape you want to play is already in the VCR, make sure the VCR power is on and the VCR is in VCR position. (The VCR light will appear on the display panel.) Press the VCR button, then press the PLAY button.
- Other playback options and features are on pages 45 - 57.

Recording 31

Read and follow the steps below to record a television program.

1

Turn on the TV and set it to channel 3 or 4, whichever the CH3/CH4 switch on the back of the VCR is set to.

2

Insert a tape with its record tab intact (see page five) in the VCR. The power will come on, and the Cassette-Inside light will appear.

3

Press the VCR button on the remote control.

4

If the VCR light appears on the display panel of the VCR, go to step 5. If the VCR light does not appear, press the VCR/TV button once.

5

Press the (Tape) SPEED button on the remote control until the desired tape speed (see page 36) appears on the TV screen. The tape speed will disappear from the screen after about five seconds.

6

Use the CH(annel) Up/Down buttons or the Number buttons to select the channel to be recorded.

7

Press the REC(ord)/OTR button once to start recording.

8

To pause the recording (for example, during commercials), press the PAUSE/STILL button once. To start recording again, press the REC(ord)/OTR button or the PAUSE/STILL button again.

9

To stop recording, press the STOP button.

1 Turn on the TV.

2 Insert a tape in the VCR.

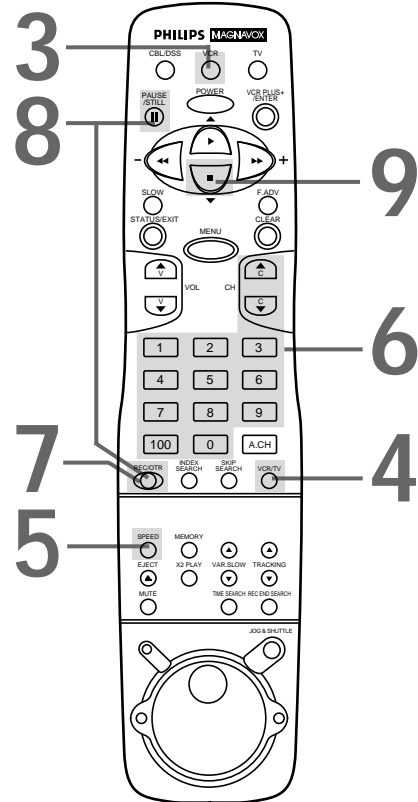

Helpful Hints

- If the REC(ord)/OTR button is pressed when there is not a tape in the VCR, NO CASSETTE will flash on-screen.
- If the REC(ord)/OTR button is pressed while a tape without a record tab is in the VCR, the VCR will eject the tape and PROTECTED CASSETTE CANNOT RECORD will flash on-screen.
- Other recording options are on pages 32 - 44.
- You can change the tape speed while the VCR is recording, but some distortion will appear on the tape.
- The VCR will record in a preset volume.

32 Recording One Channel/Watching Another

1

Press the VCR button.

2

Start a recording (see page 31).

3

Press the **VCR/TV** button to put the VCR in TV position. The VCR light will disappear from the VCR's display panel.

4

Press the **TV** button, then press the **CH(annel) Up/Down** or **Number** buttons to choose the channel you want to watch at the TV. Or, use the TV remote control to select the channel you want to watch.

5

To return to the channel being recorded, press the **TV** button, then use the **Number** buttons to select channel **03** or **04** (whichever channel the CH3/CH4 switch on the back of the VCR is set to).

Or, if the VCR remote control doesn't operate your TV, use the TV remote control to select channel 03 or 04.

6

Press the VCR button.

7

Press the **VCR/TV** button to put the VCR in VCR position. The VCR light will appear on the display panel. The channel being recorded will appear on-screen.

8

Press the **STOP** button to stop the recording.

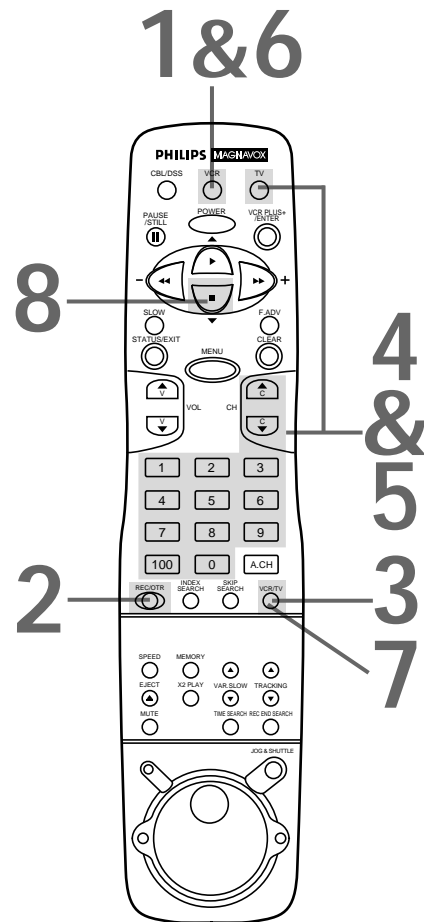

Helpful Hints

- If your remote control operates your TV, press the TV button, then use the CH(annel) Up/Down buttons on the remote control to select TV channels. Details are on page 20.
- If you use a Cable Box or Satellite System hookup, you may not be able to watch one channel while recording another. See pages eight-nine for details.
- If you don't receive channels, check your hookups, then follow the instructions above carefully.

One Touch Recording 33

The one touch recording (OTR) function allows you to program an immediate timed recording 30 minutes to eight hours long without setting the timer. Before you begin, make sure:

- Channels are programmed.
- The desired recording speed (SP, LP, or SLP) has been selected with the (Tape) SPEED button.
- There is a tape in the VCR. Make sure the tape's record tab is intact and the tape is long enough to record the program(s).
- The VCR is in VCR position. The VCR light will appear on the display panel if the VCR is in VCR position. If the VCR light does not appear, press the VCR/TV button once.

1

Press the **VCR** button.

2

Press the **CH(annel) Up/Down** buttons or the **Number** buttons to select the channel you want to record.

3

Press the **REC(ord)/OTR** button repeatedly until the desired recording length (30 minutes to eight hours) appears in the upper left corner of the screen. Recording will begin immediately.

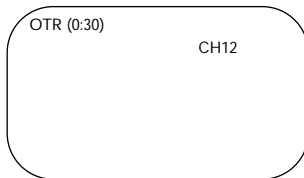

4

To stop an OTR before recording is finished, press the **STOP** button or the **POWER** button. To cancel the OTR but continue recording, press the **REC(ord)/OTR** button until **REC** appears in the upper left corner of the TV screen.

(REC will not appear in the upper left corner of the TV screen if the selected status display mode is ON SCREEN OFF. Details are on page 26.)

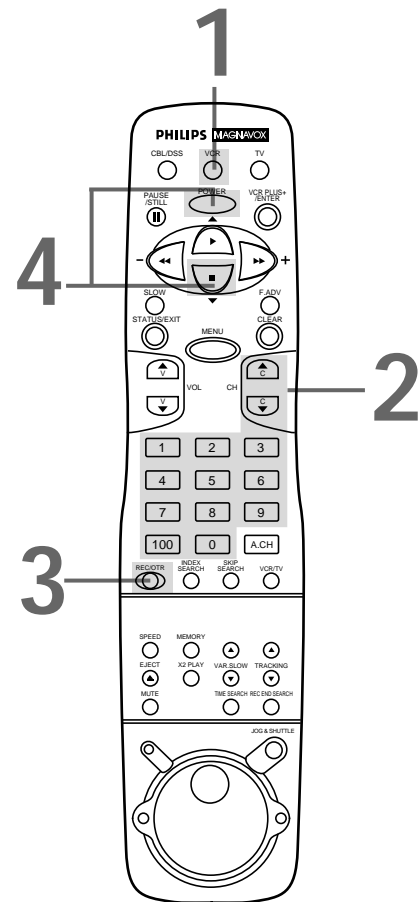

Helpful Hints

- To check the time remaining for an OTR after the OTR has been set, press the **STATUS/EXIT** button.
- To change the recording length while an OTR is in progress, press the **REC(ord)/OTR** button until the desired length appears on-screen.
- If you begin an OTR when a recording is paused, the OTR will begin.
- You can not pause recording (for example, during commercials) during an OTR.
- If the preset time for a timer recording comes up during an OTR, the OTR has priority.

34 Timer Recording

Follow the steps below to program your VCR to record TV programs while you're away from home. You can program up to eight timer recordings. For each one, the VCR will turn itself on, record, and turn itself off automatically. Before you begin make sure:

- Channels are programmed.
- The clock is set.
- There is a tape in the VCR. Make sure the tape's record tab is intact and the tape is long enough to record the program(s).
- The VCR is in VCR position. The VCR light will appear on the display panel when the VCR is in VCR position. If the VCR light does not appear, press the VCR/TV button once.

Do each step within 60 seconds of completing the previous step. If you don't, you may start again at step 1.

1

Press the VCR button, then press the MENU button.

TO SELECT PUSH NO. SHOWN
 1 PROGRAM
 2 VCR SET UP
 3 TUNER SET UP
 4 SET CLOCK
 5 CABLE BOX CONTROLLER
 6 REMOTE LOCATOR

TO END PUSH EXIT

2

Press the Number 1 button to select PROGRAM.

TO SELECT PUSH NO. SHOWN
 1 ONCE
 2 DAILY
 3 WEEKLY
 4 PROGRAM REVIEW

TO END PUSH EXIT

3

Select a once, daily or weekly recording.

- **Press the Number 1 button to select ONCE.** The VCR will record a TV program on any day you choose, up to 12 months away.
- **Press the Number 2 button to select DAILY.** The VCR will record every day from Monday to Friday – starting at the same time and for the same length of time.
- **Press the Number 3 button to select WEEKLY.** The VCR will record on the same day, at the same time, and for the same length of time every week.

Daily
Recording
Menu
Screen

DAILY PROGRAM (MON-FRI)
PROGRAM -1 2 3 4 5 6 7 8-

SELECT PROGRAM NUMBER
TO END PUSH EXIT

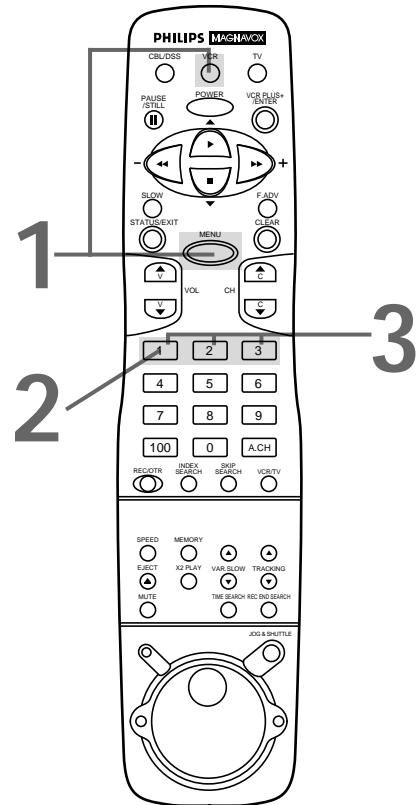

Helpful Hints

- If you need to make a correction while programming a timer recording, press the CLEAR button until the cursor is flashing on the item you want to change. Then enter the correct information.
- If you are not using the Cable Box Controller, you must set CABLE BOX CONTROLLER to OFF. Details are on pages 38 - 39.

4

Use the Number buttons (1 - 8) to select a slot in which to store the timer recording. There are eight timer recording slots. Open slots will flash on-screen.

NOTE: If you enter a number for a slot that has already been used to store a timer recording, PREVIOUSLY SET PROGRAM will appear on-screen for a few seconds. Then information about the program in that slot will appear. If this happens, press the STATUS/EXIT button twice. Then start again at step 1.

5

Enter the channel you want to record.

- If you have a basic antenna or cable hookup (as shown on pages six - seven) enter the channel of the TV program you want to record. (Enter a 0 before all-single digit channels.)
- If you are recording from line input, press 0, 0. AV REAR will appear on-screen.
- If you are using a Cable Box/DSS Receiver, enter the Cable Box/DSS Receiver output channel (channel 03 or 04). *Details are on page eight.*
- If the Cable Box Controller is set to ON, enter the cable channel you want to record. *Details are on pages 38 - 39.*

ONE TIME PROGRAM
PROGRAM 1
CHANNEL --

TO CORRECT PUSH CLEAR
TO END PUSH EXIT

6

Press two Number buttons for the hour(s) you want the recording to begin. Press two Number buttons for the minute(s) you want the recording to begin. Press 1 for AM or 2 for PM. For example, for 9:30 PM, press 09, 30, 2.

ONE TIME PROGRAM
PROGRAM 1
CHANNEL 10
TIME ON -- : --

TO CORRECT PUSH CLEAR
TO END PUSH EXIT

7

Enter the recording's stop time.

Follow the instructions in step 6 to set the recording's stop time (AM or PM will be set automatically).

ONE TIME PROGRAM
PROGRAM 1
CHANNEL 10
TIME ON 09:30 PM
TIME OFF -- : --

TO CORRECT PUSH CLEAR
TO END PUSH EXIT

Instructions continue on page 36.

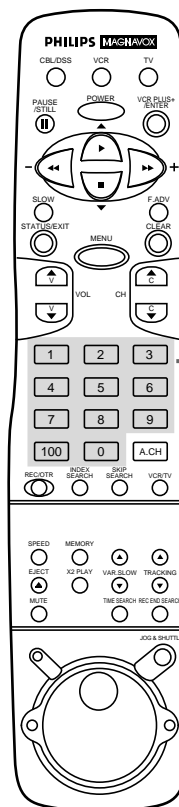

Helpful Hint

- Entries that do not match the VCR's internal clock or calendar will cause a question mark (?) to appear on-screen.

36 Timer Recording (cont'd)

8

Press the Number 1 button to record in SP speed, press the Number 2 button to record in LP speed, or press the Number 3 button to record in SLP speed. (For details, see the chart below.) You cannot use the (Tape) SPEED button at this time.

ONE TIME PROGRAM
 PROGRAM 1
 CHANNEL 10
 TIME ON 09:30 PM
 TIME OFF 11:00 PM
 REC SPEED SLP
 SP=1 LP=2 SLP=3
 TO CORRECT PUSH CLEAR
 TO END PUSH EXIT

9

Press two Number buttons for the month and two Number buttons for the day you want to record the program. For example, for July 10, 1997, press 07, 10. The day of the week and the year will appear automatically (you cannot program the VCR to record more than one year in advance).

ONE TIME PROGRAM
 PROGRAM 1
 CHANNEL 10
 TIME ON 09:30 PM
 TIME OFF 11:00 PM
 REC SPEED SLP
 START DATE 07/10/97
 THU
 TO CORRECT PUSH CLEAR
 TO END PUSH EXIT

10

Press the STATUS/EXIT button. PROGRAM WAS COMPLETED / PLEASE TURN OFF VCR FOR TIMER RECORDING will appear on-screen (if PROGRAM NOT COMPLETED appears, try again from step 1). In three seconds the on-screen display will disappear.

11

Turn off the VCR power. The Timer light will appear. The VCR must be turned off for a timer recording to take place. (If the timer recording will take place several hours or days from now, you may use the VCR until time for the recording. Just turn off the VCR a few minutes before the recording starts.) If you forget to turn off the VCR, PLEASE TURN OFF VCR FOR TIMER RECORDING flashes on your TV screen two minutes before a timer recording starts. Remove the message by pressing the CLEAR button.

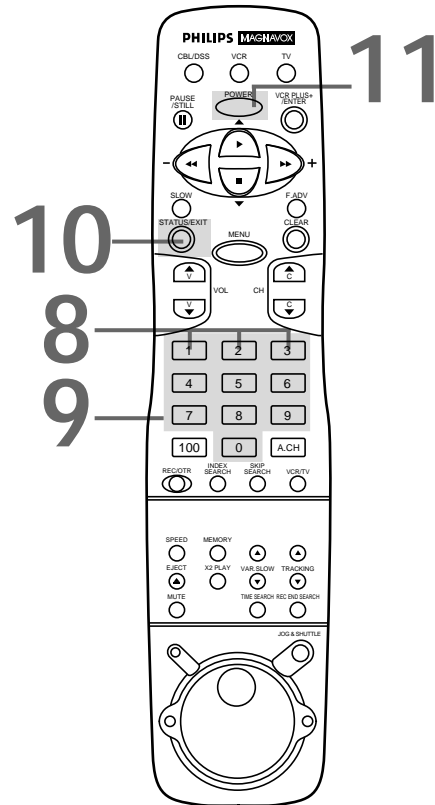

The VCR must be off for a timer recording to take place! Make sure there is a tape in the VCR.

Tape Speeds This chart shows the recording/playback time for three types of video cassettes (T160, T120, and T60). There are three playback speeds: SP, LP, and SLP. During playback, the VCR selects the tape speed automatically. When recording, you can change the tape speed using the (Tape) SPEED button (see pages 25 and 31).	Tape Speed	Maximum Record/Playback Time		
	Type	T160	T120	T60
SP (Standard Play)	2 hrs. 40 mins.	2 hrs.	2 hrs.	1 hr.
LP (Long Play)	5 hrs. 20 mins.	4 hrs.	4 hrs.	2 hrs.
SLP (Super Long Play)	8 hrs.	6 hrs.	6 hrs.	3 hrs.

Checking or Cancelling Timer Recordings

1

With the VCR on and in VCR position (the VCR light will appear on the display panel), **press the VCR button, then press the MENU button.**

2

Press the Number 1 button to select PROGRAM.

3

Press the Number 4 button to select PROGRAM REVIEW. The timer recording information for the program in the lowest numbered slot will appear on-screen. If no timer recordings are set, nothing will happen when you press the Number 4 button.

4

Press the Number 1 button repeatedly to review all programmed timer recordings. If you don't press the Number 1 button in 10 seconds, the VCR will automatically display information about the next programmed timer recording. This will continue until all timer recordings have been displayed. Then the menu will disappear.

5

To cancel the timer recording displayed, press the CLEAR button. Either the display will disappear or information about other timer recordings will appear. If you do not press any other buttons, the display will disappear after all timer recordings have been displayed.

6

Repeat steps 1 - 4 to make sure you have cleared the correct timer recording.

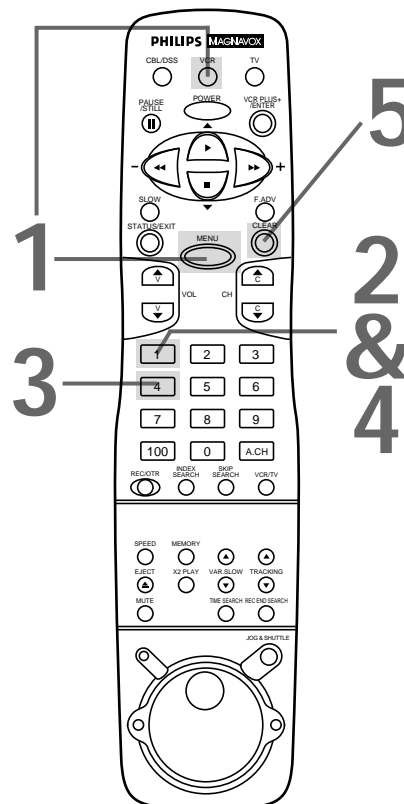

Helpful Hints

- *CLASH* may flash on the screen when you finish setting a timer recording. This means that the timer recording you just programmed and another timer recording overlap, and thus the current timer recording will not be carried out. In this case, cancel the overlapping timer recording.
- If the preset time for a timer recording comes up during an OTR, the OTR has priority.
- To stop a started timer recording, press the STOP/EJECT button on the VCR.
- If the power fails for more than one hour, programmed timer recordings will be lost. If this occurs, reset the clock before re-programming the timer recording(s).

See page 58 for more hints.

38 Setting Up the Cable Box Controller

Follow the steps below to set up the Cable Box Controller. Then the VCR will automatically select the channel at the Cable Box during a timer recording. Before you begin, make sure:

- The VCR, TV, and Cable Box are connected. *Details are on page eight.*
- You place the Cable Box on top of the VCR. Make sure the front of the Cable Box is close to the Cable Box Transmitters on the VCR (see illustration).
- You make each entry within 60 seconds of the previous entry. (If you do not, you may start again at step 3.)
- Complete the steps on page 21 before setting up the Cable Box Controller. This will allow you to find your Cable Box code. If the remote control will not control your Cable Box, the VCR's internal Cable Box Controller will not change channels during a timer recording, either.

1

Go to page 21 and find your Cable Box code.

2

Turn on the Cable Box.

3

Press the VCR button, then press the MENU button.

4

Press the Number 5 button to select CABLE BOX CONTROLLER.

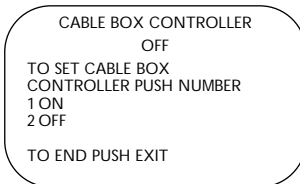

5

Press the Number 1 button to select ON. ON will appear on-screen below CABLE BOX CONTROLLER.

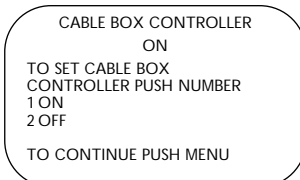

1

Find your Cable Box code.

2

Turn on the Cable Box.

3

5

4

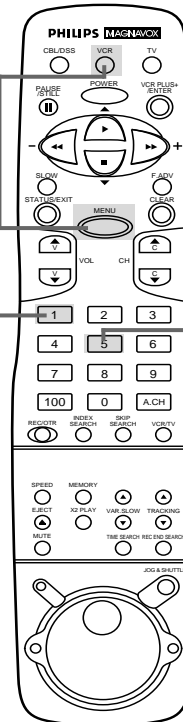

Positioning the Cable Box

Place the Cable Box on top of the VCR. The Cable Box should tilt upward slightly. You may need to place a small object under one side of the Cable Box in order to tilt the Cable Box. It is best to place the Cable Box beyond the center of the VCR or along the back of the VCR.

If the Cable Box does not receive the signals, slide the Cable Box to the right or left, or move it toward the back of the VCR until you find the best position. The signal could be distorted if it travels through glass repeatedly. For this reason, if your equipment is in an entertainment center with glass doors, leave the glass doors open.

Do not block any ventilation openings of the VCR or the Cable Box.

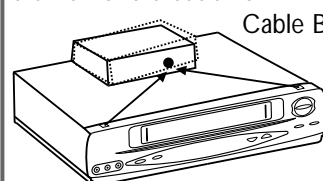

Cable Box Transmitters on VCR

Setting Up the Cable Box Controller (cont'd) 39

6

Press the **MENU** button, then use the **Number** buttons to enter the code for your brand of Cable Box.

If ? appears after you enter the code, the number you entered is incorrect. Press the **CLEAR** button, then enter the code again.

SELECT CODE NUMBER OF YOUR CABLE BOX

--
REFER TO INSTRUCTION BOOK FOR CODES

TO END PUSH EXIT

7

Press the **MENU** button. In 15 seconds, the VCR will send channel signals to your Cable Box. If the channel of the Cable Box changes on the display panel of the Cable Box, go to step 8. (The channel number may also appear on-screen.) If the channel of the Cable Box does not change on the display panel of the Cable Box, press the **STATUS/EXIT** button, then repeat steps 1 - 7 using another Cable Box code at step 6.

8

Use the **Number** buttons to enter the Cable Box output channel (channel 03 or 04).

SELECT OUTPUT CH OF YOUR CABLE BOX

03

TO CONTINUE PUSH MENU
TO CORRECT PUSH CLEAR
TO END PUSH EXIT

9

Press the **MENU** button. **CABLE BOX CONTROL IS ON** will appear on-screen for eight seconds, then disappear. To set up the VCR Plus + programming system, follow the instructions on pages 40 - 41.

CABLE BOX CONTROL IS ON

TO SET UP VCR PLUS+
CROSS REFERENCE CHANNEL
MAP REFER TO
INSTRUCTION BOOK.

There is no guarantee that the VCR will control your Cable Box.

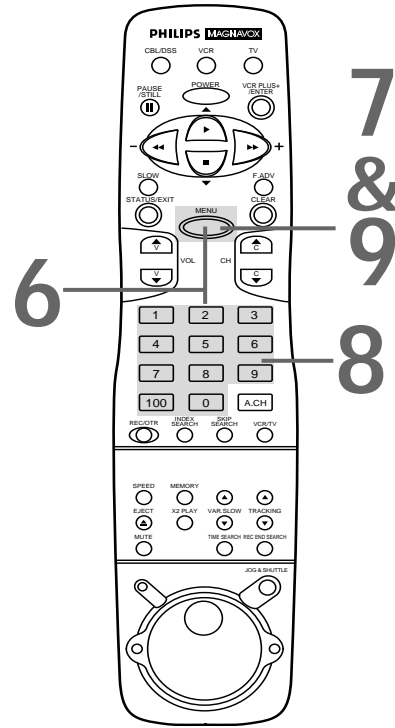

Helpful Hints

- If you make a mistake, press the **CLEAR** button until the cursor is flashing on the item you want to change, then enter the correct information.
- If your Cable Box does not respond to any of the codes on page 21, the Cable Box Controller will not change channels at the Cable Box during a timer recording. If this happens, you must turn on the Cable Box and tune it to the channel you want to record before a timer recording begins.
- The VCR will only change the Cable Box channel during timer recordings.
- You cannot set **CABLE BOX CONTROLLER** to ON if **AUTO CLOCK** is set to ON. Details are on page 16.
- To set the **CABLE BOX CONTROLLER** to OFF, follow steps 3 - 4 on page 38. Then, press the **Number 2** button. The menu will disappear in a few seconds.

Setting Up the VCR Plus+ Programming System (cont'd) 41

2

Now, compare the channel numbers you have written in the VCR PLUS+ CH. and CABLE/TV CH. columns. You'll notice that some stations have VCR Plus+ and Cable/TV channel numbers that are the same, and other stations have channel numbers that do not match. Where the channel numbers DO NOT match, you must tell the VCR the VCR Plus+ and Cable/TV channel numbers according to the following steps.

- Make each entry within 60 seconds of the previous entry.

3

Press the VCR button, then press the MENU button.

4

Press the Number 2 button to select VCR SET UP.

TO SELECT PUSH NO. SHOWN
 1 REPEAT PLAY OFF
 2 ON SCREEN MODE
 3 AUDIO OUT
 4 LANGUAGE
 5 VCR PLUS+ REF. MAP

TO END PUSH EXIT

5

Press the Number 5 button to select VCR PLUS+ REF. MAP.

VCR PLUS+ CROSS REF. MAP
 VCR PLUS+ CABLE/TV
 98 98
 99 99
 1 -----> 1
 2 2

TO SELECT CH PUSH CH UP/
 DOWN THEN ENTER CH NO.
 TO END PUSH EXIT

6

Look at the lists you filled in on page 40. For stations whose VCR Plus+ and Cable/TV channels do not match, press the CH(annel) Up/Down buttons until the arrow is beside the VCR Plus+ channel you need. Then, press the Number buttons to enter the corresponding Cable/TV channel from your list. (Enter a "0" before single-digit channels.) Continue this process until you have entered all the stations on your list.

VCR PLUS+ CROSS REF. MAP
 VCR PLUS+ CABLE/TV
 98 98
 99 99
 1 -----> 23
 2 2

TO SELECT CH PUSH CH UP/
 DOWN THEN ENTER CH NO.
 TO END PUSH EXIT

7

Press the STATUS/EXIT button to exit.

2

Examine the lists on page 40.

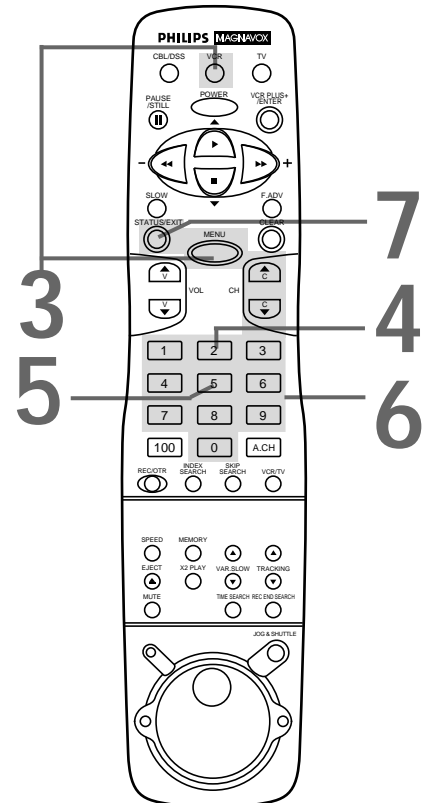

Helpful Hints

- To correct a Cable/TV channel number, repeat the steps on this page.
- To clear a Cable/TV channel number, repeat steps 3-5 on this page. Then, press the CH(annel) Up/Down buttons to select it. Then press the CLEAR button. Press the STATUS/EXIT button to exit.
- Always enter a "0" before single-digit channels.
- To select line input for the Cable/TV channel, press 0,0. AUX will appear on-screen.
- When you receive the VCR from the factory, all the VCR Plus+ channel numbers and Cable/TV channel numbers are the same.

42 Timer Recording With the VCR Plus+ Programming System

Follow the steps below to program a timer recording using the PlusCode programming numbers in your TV guide. Before you begin, make sure:

- Channels are programmed (page 12).
- The VCR Plus+ and Cable/TV channel numbers are entered (pages 40 - 41).
- The clock is set (pages 14 - 17).
- There is a tape in the VCR. Make sure the tape's record tab is intact and the tape is long enough to record the program(s).
- The VCR power is on and the VCR light appears on the display panel of the VCR. If it does not, press the VCR/TV button once.

Complete each step within 60 seconds of completing the previous step. If you don't, you may return to step 1.

1

Press the **VCR** button.

2

Press the **VCR PLUS+ /ENTER** button on the remote control. The on-screen display shown below will appear.

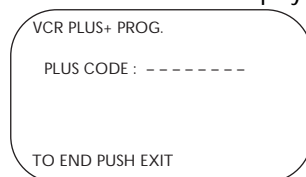

3

Press the **Number** buttons to enter the **PlusCode programming number** of the program you wish to record (this number is different for every program, and it can be four to eight digits long). **Finally, press the VCR PLUS+ /ENTER button.**

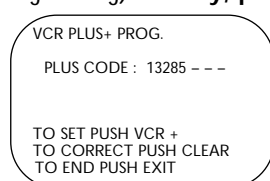

4

To record the program once, press the **Number 1** button to select **ONCE**. To record the same program every day from **Monday through Friday**, press the **Number 2** button to select **DAILY**. To record the same program every week on the same day (such as every Saturday), press the **Number 3** button to select **WEEKLY**.

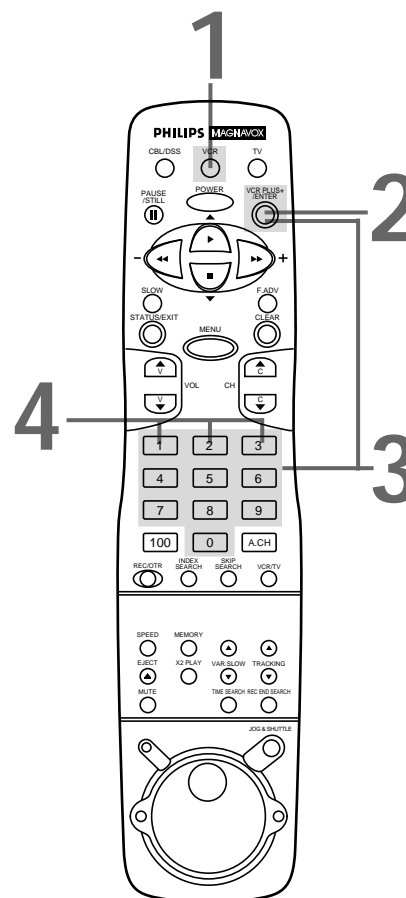
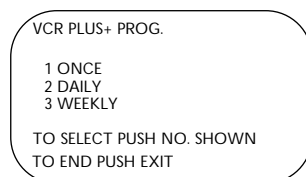

Helpful Hints

- If **CODE ERROR** flashes after you enter the PlusCode programming number and press the **VCR PLUS+ /ENTER** button, the number you entered was incorrect (for example, too short). If this happens, enter the correct number.
- **CLASH** may flash on the screen at step 3. This means that the timer recording you just programmed and another timer recording overlap, and thus the current timer recording will not be carried out.

Timer Recording With the VCR Plus+ Programming System (cont'd) 43

5

Press the Number 1 button to record in SP speed, the Number 2 button to record in LP speed, or the Number 3 button to record in SLP speed. Your selection will appear to the right of REC SPEED on-screen, although SP=1 LP=2 SLP=3 will continue to flash. For details about tape speed, see pages 36 and 60. You cannot use the (Tape) SPEED button at this time.

ONE TIME PROGRAM		
PROGRAM	1	
CHANNEL	09	
TIME ON	10:30 PM	
TIME OFF	11:30 PM	
REC SPEED	SLP	
SP=1	LP=2	SLP=3
START DATE	10/10/97	
FRI.		
TO END PUSH EXIT		

6

Press the STATUS/EXIT button. PROGRAM WAS COMPLETED / PLEASE TURN OFF VCR FOR TIMER RECORDING should appear on the screen. After three seconds, the on-screen display will disappear.

7

Press the POWER button to turn off the VCR power. The Timer light will appear. The Timer light will flash if there is not a tape in the VCR.

If the timer recording will take place several hours or days from now, you may use the VCR until time for the recording. Just turn off the VCR a few minutes before the recording starts.

The VCR must be turned off for a timer recording to take place. If you forget to turn off the VCR, PLEASE TURN OFF VCR FOR TIMER RECORDING flashes on your TV screen two minutes before a timer recording starts. You can remove the message by pressing the CLEAR button.

The VCR must be off for a timer recording to take place! Make sure there is a tape in the VCR.

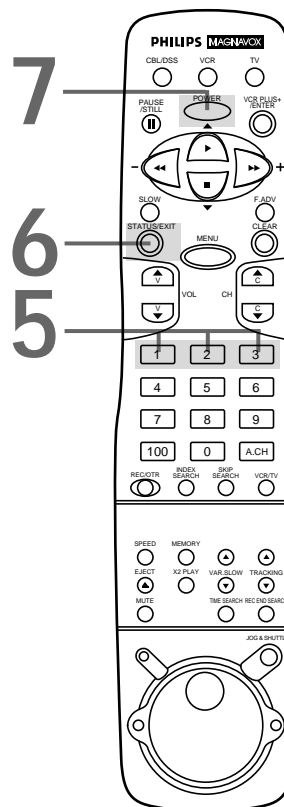

Helpful Hints

- To exit the VCR Plus+ programming system at any time, press the STATUS/EXIT button. The display will disappear from the TV screen.
 - If the preset time for a timer recording comes up during an OTR, the OTR has priority.
 - To stop a started timer recording, press the STOP/EJECT button on the VCR.
 - If the power fails for more than one hour, programmed timer recordings may be lost. Reset the clock before re-programming the timer recordings.
 - If you are using a Cable Box/DSS Receiver, timer recordings are programmed differently. Details are on page eight.
- See page 58 for more hints.

44 Rerecording (Tape Duplication)

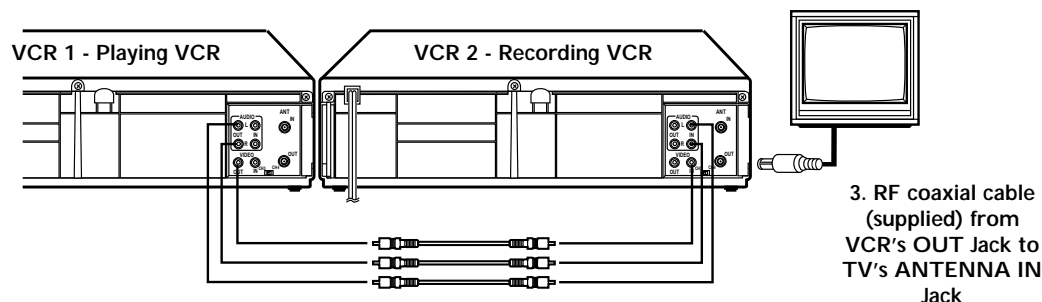

1. Audio cables from **AUDIO OUT** Jacks of VCR 1 to **AUDIO IN** Jacks of VCR 2
2. Video cable from **VIDEO OUT** Jack of VCR 1 to **VIDEO IN** Jack of VCR 2

- Audio and Video cables are not supplied.

The instructions on this page show you how to copy tapes. The illustration uses two VCRs just like yours. Different VCRs may operate differently.

NOTE: Unauthorized recording of copyrighted television programs, video tapes, or other materials may infringe on the rights of copyright owners and violate copyright laws.

1

Make the connections shown above.

2

VCR 1 will play your tape. **Insert a prerecorded tape in VCR 1.**

1. If the tape does not have a record tab, playback begins. If this happens, press the **STOP/EJECT** button on VCR 1 once.

3

VCR 2 will record your tape. **Insert a blank tape in VCR 2.** Make sure the VCR 2 power is on and VCR 2 is in VCR position. (The VCR light will appear on the display panel. If it does not, press the **VCR/TV** button once.)

4

Turn the TV on and set it to channel 3 or 4, whichever channel the **CH3/CH4** switch on VCR 2 is set to.

5

Point the remote control at VCR 2. Press Number buttons 0, 0, 1 or 0, 0, 2. (See *Helpful Hints* at right.)

6

Point the remote control at VCR 2. Use the (Tape) SPEED button to select SP, LP, or SLP.

7

Press the PLAY button on VCR 1 and the REC(ord)/OTR button on VCR 2 at the same time.

To stop recording, press the **STOP/EJECT** button on VCR 1, then press the **STOP/EJECT** button on VCR 2.

Helpful Hints

- If you use the **AUDIO** and **VIDEO IN** Jacks on the back of VCR 2, press Number buttons 0, 0, 1. **AV REAR** will appear on-screen.
- If you use the **AUDIO** and **VIDEO IN** Jacks on the front of VCR 2, press Number buttons 0, 0, 2. **AV FRONT** will appear on-screen.

Repeat Playback 45

Repeat Playback

Follow the steps below to program the VCR to play a tape over and over.

1

Press the VCR button.

2

Press the MENU button to bring up the main menu display.

TO SELECT PUSH NO. SHOWN
1 PROGRAM
2 VCR SET UP
3 TUNER SET UP
4 SET CLOCK
5 CABLE BOX CONTROLLER
6 REMOTE LOCATOR

TO END PUSH EXIT

3

Press the Number 2 button to select VCR SET UP.

TO SELECT PUSH NO. SHOWN
1 REPEAT PLAY OFF
2 ON SCREEN MODE
3 AUDIO OUT
4 LANGUAGE
5 VCR PLUS+ REF. MAP

TO END PUSH EXIT

4

Press the Number 1 button so that ON appears to the right of REPEAT PLAY on-screen.

5

Press the STATUS/EXIT button to exit. Now, when a tape has finished playing, the VCR will rewind it and start playback again. (TV programming will appear while the tape is rewinding.)

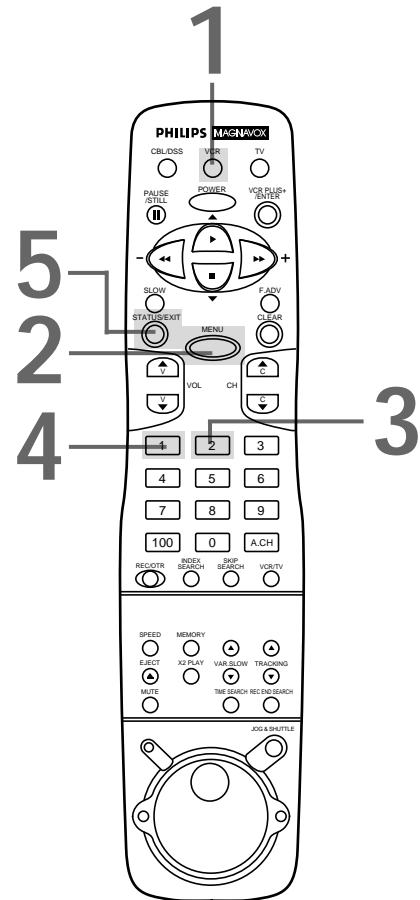

Helpful Hints

- The VCR will stay in Repeat Play mode until you cancel Repeat Play mode. To do this, follow steps 1 - 3 above. At step 4, press the Number 1 button so that OFF appears to the right of REPEAT PLAY. Press the STATUS/EXIT button to exit.
- The real time counter memory does not function during Repeat Play mode.

46 Time Search

Time Search

Follow the steps below to program the VCR to search forward or backward a specific length of time.

1

Press the **VCR** button.

2

Press the **TIME SEARCH** button to bring up the time search display. There must be a tape in the VCR.

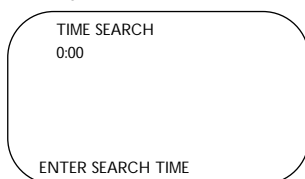

3

Within 10 seconds, use the **Number** buttons to enter the desired length of time you want to skip forward or backward. For example, for 1 hour, 25 minutes, press Number buttons 1, 2, 5. Or, for five minutes, press Number buttons 0, 0, 5. (Make an entry within 10 seconds of pressing the TIME SEARCH button. Otherwise, the VCR will exit Time Search mode.)

4

Within 10 seconds, press the **Fast Forward** button or the **Rewind** button to skip forward or backward. The VCR will skip over the specified length of time, then begin playback. (The time counts down on-screen as the searching progresses.)

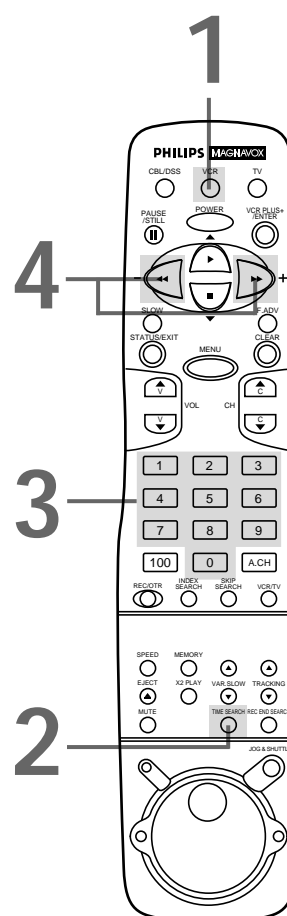

Helpful Hints

- If you want to search for more than 59 minutes, you must enter the length of time in hours and minutes. For example, to search forward 70 minutes, press 1,1,0 at step 3.
- You can not enter the TIME SEARCH menu when you are in Recording mode.
- You can remove the Time Search display by pressing the TIME SEARCH button again.
- To cancel the Time Search when the VCR is fast forwarding or rewinding, press the STOP button once or the TIME SEARCH button twice.

Index Search 47

Index Search

This feature allows you to index the starting points of programs that you have recorded on a tape. Then, you can easily rewind or fast forward to that point.

Example:

If you are watching program number 4 and you want to fast forward to program number 7, skip three programs.

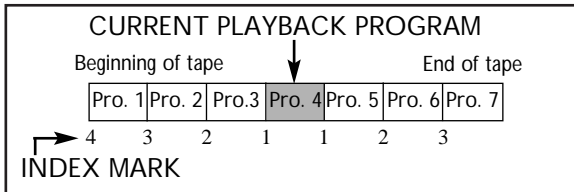

1

Press the **VCR** button.

2

Press the **INDEX SEARCH** button to bring up the index search display. There must be a tape in the VCR.

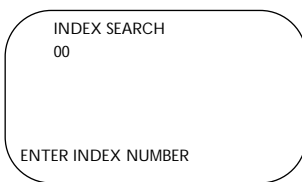

3

Within 10 seconds, use the **Number** buttons to enter the number of programs that you want to skip. For example, to skip three programs, press **Number** buttons 0, 3. If you do not make an entry within 10 seconds, the VCR will exit Index Search mode.

4

Within 10 seconds, press the **Fast Forward** button or the **Rewind** button to skip forward or backward. The VCR will fast forward or rewind to the beginning of the desired program, then begin playback. (The program numbers count down on-screen as the searching progresses. To remove the on-screen counter, press the **INDEX SEARCH** button once.)

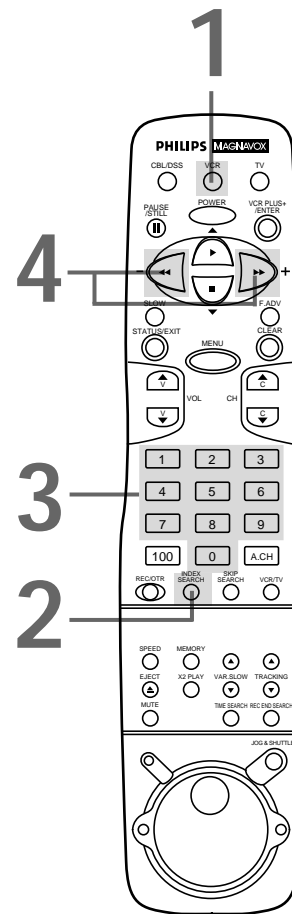

Helpful Hints

- Every time an index mark is skipped, the number of programs decreases by one.
- Up to 20 index marks may be searched.
- This function will not operate in recording mode.
- Press the **STOP** button to stop the search.
- An index mark will be made automatically when the **REC(ord)/OTR** button is pressed, or at the beginning of a **Timer Recording** or **OTR**.
- The index mark is not made if the **PAUSE/STILL** button is pressed and released during recording.
- The time gap between index marks should be greater than 1 minute for **SP** recording, 2 minutes for **LP** recording, and 3 minutes for **SLP** recording.

48 Record End Search/Skip Search

Record End Search

This function enables you to search forward to an unrecorded portion of the tape (or to the point at which recording was stopped). Make sure the tape is fully rewound.

1

Press the **REC(ord) END SEARCH** button. The VCR begins fast forwarding to the beginning of the first blank portion of the tape. **SEARCHING FOR REC END** will appear on-screen during the search.

The VCR will automatically stop when the blank portion is reached. **REC END SEARCH COMPLETED** will appear on-screen briefly.

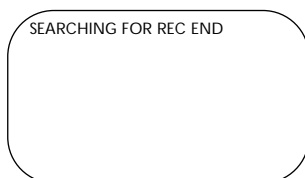

Skip Search

This function enables you to skip forward 30 seconds at a time during tape playback.

1

During tape playback press the **SKIP SEARCH** button.

The VCR will skip forward 30 seconds, then resume normal playback.

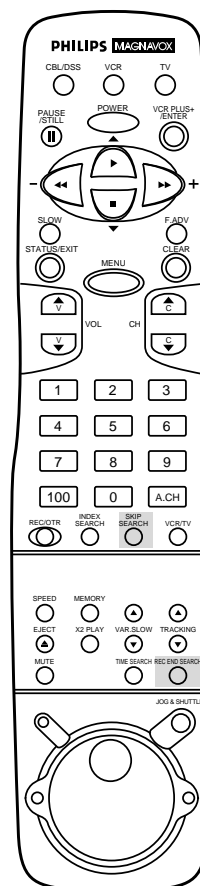

Helpful Hint

- Press the **STOP** button to cancel a Record End Search or a Skip Search.

Real Time Counter Memory 49

Real Time Counter Memory

Follow the steps below to reset the real time counter to zero at a tape location you want to refer to later.

1

Play, fast forward, or rewind a tape to the location that you would like to refer to later. Press the **STOP** button or the **STOP/EJECT** button to stop the tape.

2

Press the **STATUS/EXIT** button. The status display will appear on-screen for about five seconds.

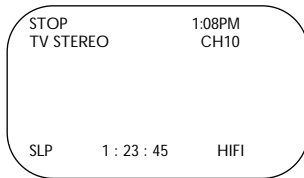

3

While the status display is still on-screen, press the **CLEAR** button to reset the real time counter to zero.

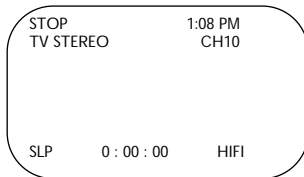

4

While the real time counter is still on-screen, press the **MEMORY** button so that M appears to the left of the real time counter on-screen.

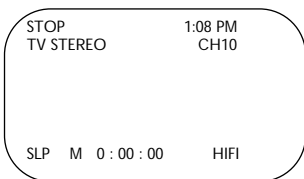

5

To go to a tape location where the real time counter was reset to zero, press the **Rewind** button or the **Fast Forward** button when playback is stopped. When the tape reaches the point at which the real time counter was reset to zero, the tape will stop. Press the **PLAY** button to watch the tape.

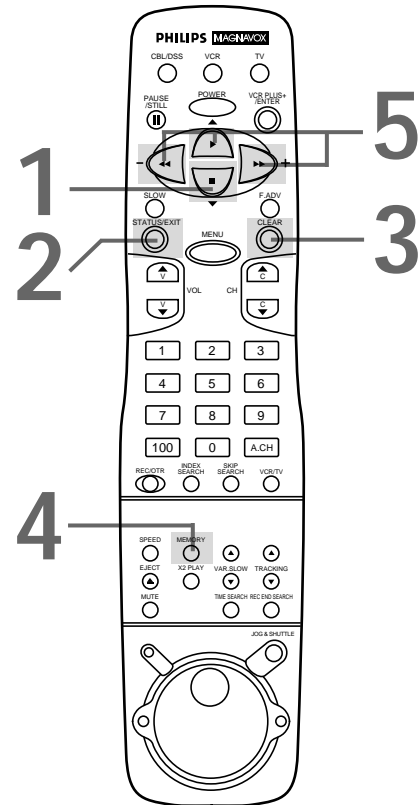

Helpful Hints

- The **MEMORY** button does not function when **REPEAT PLAY** is set to **ON**. To turn **REPEAT PLAY OFF**, see the *Helpful Hints* on page 45.
- To erase a **Real Time Counter Memory**, press the **MEMORY** button until the **M** disappears from the screen.
- You may only set the real time counter to zero at one location at a time. If you try to set the real time counter to zero at a second location, the previous real time counter to zero setting will be erased.

50 Special Effects Playback

Forward and Reverse Searching (SP/LP/SLP)

1

During tape playback, **press and release the Fast Forward button or the Rewind button**. A fast forward or reverse picture search will begin.

2

To return to playback, **press the PLAY button**.

Super High Speed Searching (LP/SLP)

1

During tape playback **press the Fast Forward button or the Rewind button, then press again**. The VCR will now search in super high speed.

2

To return to normal playback, **press the PLAY button**.

Playing a Tape at Double Speed

1

During tape playback **press the X2 PLAY button**. The picture will play at twice the normal playback speed.

2

To return to normal playback, **press the X2 PLAY button again or press the PLAY button**.

Viewing a Still Picture

1

During tape playback **press the PAUSE/STILL button**. A still picture (frozen image) will appear on-screen.

2

To advance the still picture frame-by-frame, **press the F(rame). ADV(ance) button**.

3

To release the still picture and return to normal playback, **press the PLAY button or press the PAUSE/STILL button again**.

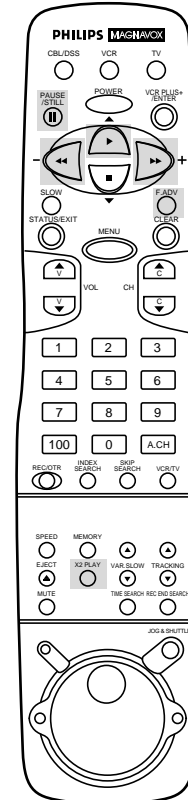

Helpful Hints

- *Slow and Still modes will automatically switch to Stop mode after five minutes to protect the VCR and the tape from damage.*
- *SP/LP/SLP means this feature will work with tapes recorded in Standard Play, Long Play, or Super Long Play.*
- *LP/SLP means this feature will work with tapes recorded in Long Play or Super Long Play. For details about tape speed, see pages 36 and 60.*
- *To reduce vertical jitter in a Still picture, press the CHANNEL Up/Down buttons on the VCR.*

Special Effects Playback (cont'd) 51

Viewing a Slow Motion Picture

1

During tape playback, **press the SLOW button**. The tape will play in slow motion.

NOTE: You can control the speed of slow motion playback by **pressing the VAR(iable). SLOW buttons**.

2

To release Slow mode and return to normal playback, **press the PLAY button** or **press the SLOW button again**.

Viewing a Picture in Slow to Fast Motion

1

Press the JOG & SHUTTLE button while in the Play or Still mode. The Jog & Shuttle Light comes on. If you do not operate the Jog Dial or Shuttle Ring within 30 seconds, the Jog & Shuttle light will go off.

2

Turn the Shuttle Ring in either direction and hold it. The more the ring is rotated, the faster the search will be. Releasing the ring stops the picture in the Still mode.

3

Turn the Jog Dial in either direction for frame-by-frame control. The faster the dial is rotated, the faster the search will be. Releasing the dial stops the picture in the Still mode.

4

Press the PLAY button to release the Still mode.

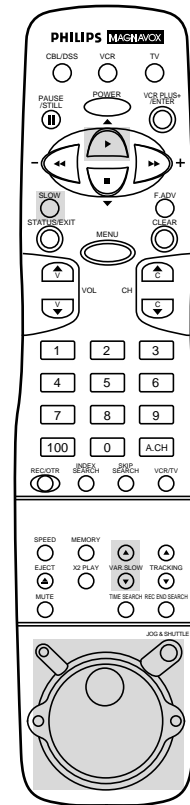

Helpful Hint

- You can do a forward or backward search by turning and holding the Shuttle Ring on the VCR while in the Play or Still mode.

52 Automatic Operation Features

The following playback features will always operate:

Automatic Playback

When you put a tape in the VCR, the power will come on automatically. If the tape's record tab is missing, playback will begin. If a timer recording is set, the power will not come on automatically when you insert a tape with the record tab intact. If a timer recording is set and the VCR power is off, the VCR will eject the tape if the record tab is missing.

Automatic Rewind, Eject, Off

When a tape is played, fast forwarded, or recorded to its end, the VCR will rewind the tape, stop, eject the tape, then turn itself off. If the real time counter memory is set, the VCR will only rewind to the point at which the counter is set to zero, then stop. The VCR will not eject the tape automatically or shut itself off.

Memory Rewind, Power Off

When the POWER button is pressed while the VCR is rewinding a tape, the VCR will turn itself off when it has finished rewinding. REWIND → POWER OFF will appear on-screen. If a real time counter memory is set, the VCR may only rewind the tape to the point at which the real time counter was set to zero, then stop and turn itself off.

Tape Eject

A tape can be ejected with the VCR power on or off (but the VCR must be plugged in). If a Timer Recording is programmed, a tape can only be ejected with the power on. Make sure you insert a tape and turn off the VCR power for the Timer Recording.

Automatic Operation Features (cont'd) 53

Automatic Tracking Adjustment

The VCR continually adjusts tracking automatically to give you the best possible picture quality. With some recordings, however, you may get a better picture using the manual tracking controls (see below).

Manual Tracking

To adjust the tracking manually, press the TRACKING (Up/Down) buttons **on the remote control**.

NOTES:

- The CHANNEL (Up/Down) buttons **on the VCR** adjust tracking during playback. This function is controlled only by the CHANNEL (Up/Down) buttons **on the VCR**. The CH(annel) Up/Down buttons on the remote control will not adjust tracking.
- To return tracking to the position it was in when the VCR was shipped from the factory, press the CHANNEL (Up) and CHANNEL (Down) buttons **on the VCR at the same time**.
- Tracking is returned to auto tracking when a tape is inserted, or when the STOP button is pressed to halt playback.
- When the VCR is in Slow mode, auto tracking will not work. Instead, use the TRACKING (Up/Down) buttons **on the remote control** or the CHANNEL Up/Down buttons **on the VCR** to reduce noise lines in slow motion playback.
- Manual tracking will not operate when the VCR is in Still mode. If you want to reduce noise lines in a still picture, place the VCR in Slow mode. Use the TRACKING (Up/Down) buttons **on the remote control** or the CHANNEL Up/Down buttons **on the VCR** to remove the noise lines. Then return to Still mode.

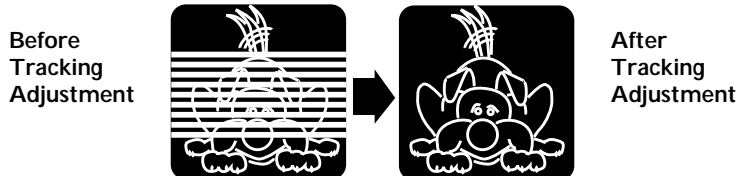

54 MTS Broadcast Stereo System

Your VCR can play recordings broadcast in Hi-Fi (high fidelity) stereo, which produces a crisp, clear sound from two sources. Your VCR also can play tapes recorded in a second audio (usually, that means your program is recorded in a second language). Of course, your VCR will play tapes recorded in monaural (single-source) sound as well.

Your VCR also will record in Hi-Fi stereo or in second audio, so when you play back that tape on the VCR, it will be in stereo or second audio. If you play back the tape on a VCR that can't play back tapes in stereo or second audio, the VCR will automatically play the tape in monaural sound.

Read the directions on this page to familiarize yourself with your VCR's stereo and second audio setups. Follow the directions on page 55 to record in stereo or second audio, or follow the directions on pages 56 - 57 to play back tapes recorded in Hi-Fi stereo.

Understanding On-Screen Displays

When you receive a signal from a channel you're watching, portions of the on-screen display shown below will appear when you press the STATUS/EXIT button on the remote control.

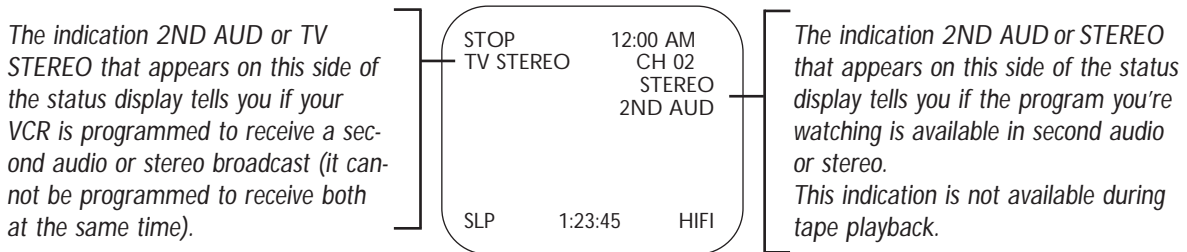

Specifically...

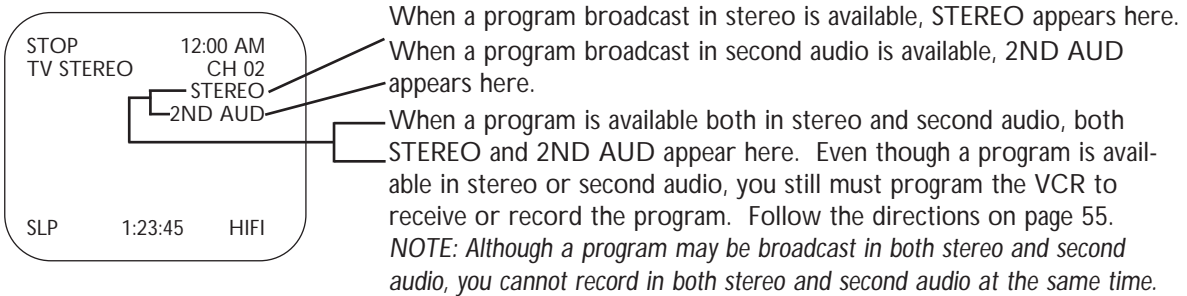

To record and play back programs broadcast in stereo, even if you have a Mono Speaker TV, just use one of the connections shown, then follow the steps on pages 55 - 57.

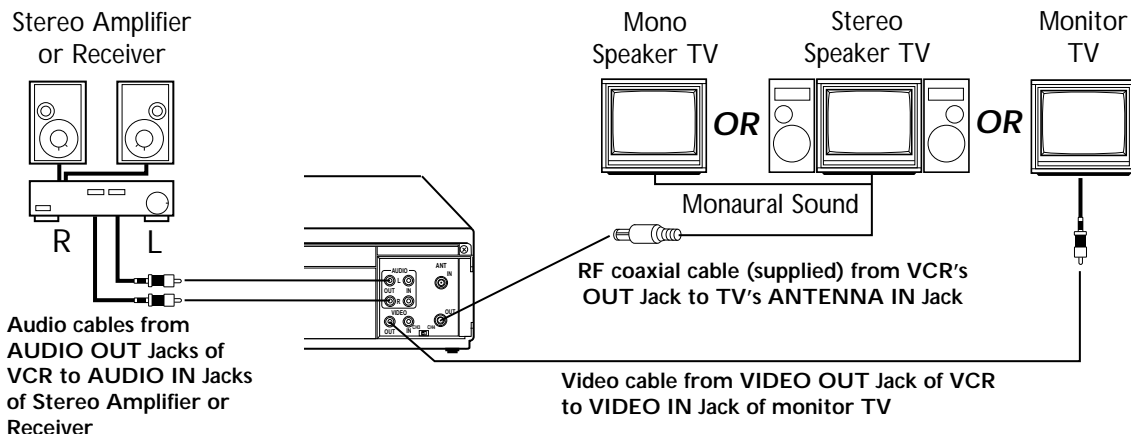

MTS Broadcast Stereo System (cont'd) 55

1

Press the VCR button, then press the MENU button.

2

Press the Number 3 button to select TUNER SET UP.

TO SELECT PUSH NO. SHOWN

1 TV	
2 CABLE TV	ON
3 AUTO PROGRAMMING	
4 ADD/DELETE CH	
5 CH MEMORY REVIEW	
6 TV STEREO	ON
7 2ND AUDIO	
TO END PUSH EXIT	

3

Press the Number 6 button to select TV STEREO or the Number 7 button to select 2ND AUDIO. ON will appear to the right of your selection.

4

Press the STATUS/EXIT button to exit.

5

To play a tape, press the PLAY button. Or, to record, select the channel to be recorded using the CH(annel) Up/Down buttons, then go to step 6.

6

Press the REC(ord)/OTR button to start recording.

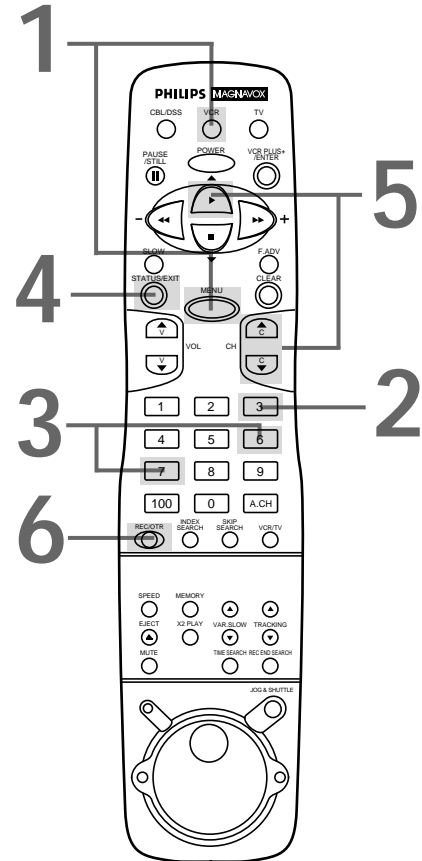

Helpful Hints

- You can only receive and record in stereo or second audio programs that are broadcast in second audio or stereo. You can only play in stereo or second audio tapes that were recorded in stereo or second audio. Please see page 54 to determine if the program you want to watch/record is being broadcast in stereo or second audio.
- If you select second audio when second audio is not available, the VCR will record normal audio.

56 Hi-Fi Stereo Sound System

Multi-Channel Television Sound System broadcasts are automatically recorded in Hi-Fi stereo sound. To play in Hi-Fi stereo tapes recorded in Hi-Fi stereo, however, you'll need to follow the steps below.

1

Press the VCR button, then press the MENU button.

2

Press the Number 2 button to select VCR SET UP.

TO SELECT PUSH NO. SHOWN
 1 REPEAT PLAY OFF
 2 ON SCREEN MODE
 3 AUDIO OUT
 4 LANGUAGE
 5 VCR PLUS+ REF. MAP
 TO END PUSH EXIT

3

Press the Number 3 button to select AUDIO OUT.

TO SELECT PUSH NO. SHOWN
 1 HIFI ON
 2 MONO
 TO END PUSH EXIT

4

Press the Number 1 button to select HIFI. ON will appear to the right of HIFI on-screen.

TO SELECT PUSH NO. SHOWN
 1 HIFI ON
 2 MONO
 TO END PUSH EXIT

5

Press the STATUS/EXIT button to exit.

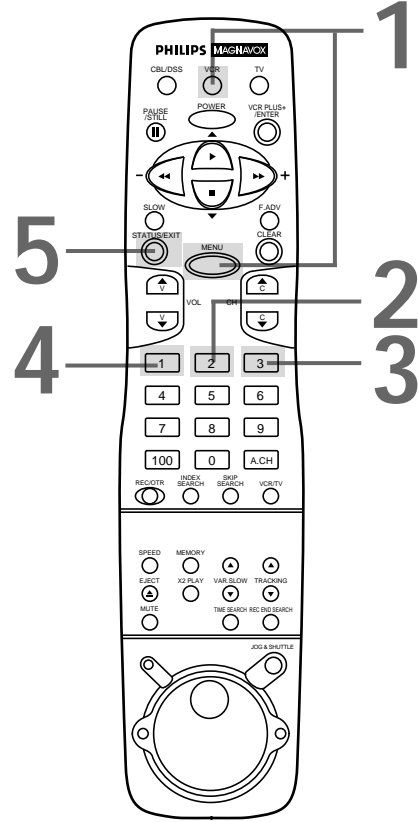

Helpful Hints

- All programs are automatically recorded in both Hi-Fi stereo sound and in monaural sound.
- The audio level of a tape recorded in Hi-Fi stereo will differ from the audio level of a tape not recorded in Hi-Fi stereo.
- Normally, HIFI should be selected from the AUDIO OUT menu for playback with Hi-Fi sound. But, you can change the selection to MONO if you want monaural audio playback. To do this, follow steps 1 - 3 above. At step 4, press the Number 2 button to select MONO. Press the STATUS/EXIT button to exit. HIFI will disappear from the status display.
- If you play non-Hi-Fi tapes while the VCR is set to HIFI, HIFI will disappear from the status display and the tape will play in monaural sound. **Additional hints are on page 59.**

Hi-Fi Stereo Sound System (cont'd) 57

6

Press the **MENU** button to bring up the main menu display.

7

Press the **Number 3** button to select TUNER SET UP.

TO SELECT PUSH NO. SHOWN
1 TV
2 CABLE TV ON
3 AUTO PROGRAMMING
4 ADD/DELETE CH
5 CH MEMORY REVIEW
6 TV STEREO ON
7 2ND AUDIO
TO END PUSH EXIT

8

Press the **Number 6** button to select TV STEREO. ON will appear to the right of TV STEREO on-screen.

9

Press the **STATUS/EXIT** button to exit.

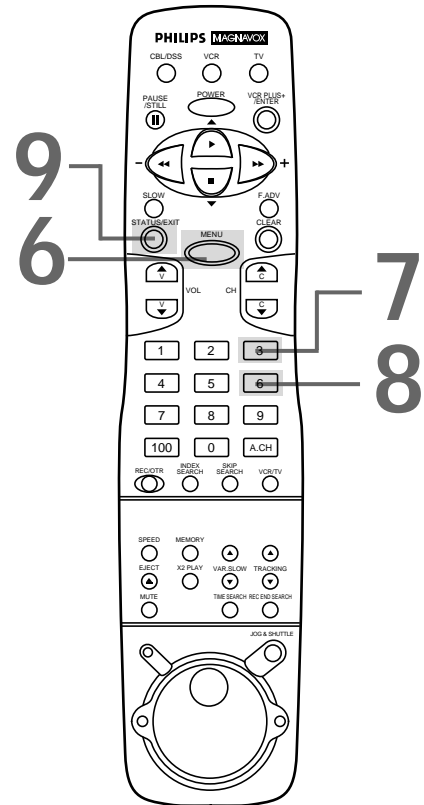

58 Helpful Hints

If you are having problems with your VCR, check the following list of problems and possible solutions before requesting service. You may be able to solve the problem yourself.

No power

- Make sure the power plug is completely connected to an AC (alternating current) outlet.
- Make sure the power is turned on.

Power Failure

- Timer recordings and the clock setting may be lost if the power fails for more than one hour. See pages 14 - 17 to reset your clock. See pages 34 - 43 to reprogram your timer recordings.

A TV program cannot be recorded.

- Check the connections between the VCR, TV, antenna/cable, and Cable Box/Digital Satellite System (if applicable) (pages six - 10).
- Make sure the tape has a record tab (page five).
- Check the TV/VCR position (page 28).
- Check the CH3/CH4 switch (pages six - nine).

The VCR will not perform a timer recording.

- Make sure the recording start and stop times are set correctly (pages 34 - 43).
- Make sure a tape is in the VCR and the tape has a record tab (page five). If, after programming a timer recording, you turn off the VCR power without putting a tape in the VCR, the Timer light will blink.
- If the record tab on a tape is missing, the VCR will eject the tape. The Timer light will blink.
- Make sure the VCR power is off.
- Make sure the clock is set (pages 14 - 17).
- The VCR may not perform or continue a timer recording if a power interruption of more than one hour occurs during the timer recording, even if the power comes back on afterward.
- If you have a Cable Box/DSS Receiver, timer recordings are programmed differently. *Details are on page eight.*
- It is best to finish programming a timer recording at least five minutes before the recording is scheduled to begin.
- 12 PM is noon; 12 AM is midnight.

There is no playback picture or the playback picture is noisy or contains streaks.

- Make sure the TV and the Cable Box/DSS Receiver, if applicable, are on the same channel as the VCR's CH3/CH4 switch (pages six - nine).
- Make sure the VCR is in VCR position (page 28). The VCR light will appear on the display panel of the VCR when the VCR is in VCR position.
- Make sure channel 3 or 4 is properly adjusted at the TV.
- Adjust the tracking (page 53).

The VCR cannot be controlled with the remote control.

- Make sure the VCR light appears on the VCR display panel. If it does not, press the VCR/TV button once.
- Aim the remote control directly at the VCR's remote sensor (page 28).
- Remove all obstacles between the remote control and the VCR.
- Inspect and/or replace the batteries in the remote control (page five).
- Press the VCR button, then try the other VCR function buttons.

The Number buttons won't work for channels above 69.

- Select CABLE TV at the TUNER SET UP menu (page 12), then let the VCR program the channels.

Helpful Hints (cont'd) 59

TV programs cannot be watched normally.

- Put the VCR in TV position. (Press the VCR/TV button so that the VCR light disappears from the display panel. For details see pages 25 and 28.)
- Check the connections between the VCR, TV, antenna/cable, and Cable Box/Digital Satellite System (if applicable). (See pages six - 10 for details.)

Tape cannot be inserted.

- Insert the tape, window side up, with the record tab facing you.
- Make sure a tape isn't already in the VCR by pressing the STOP/EJECT button on the VCR.
- Gently push on the center of the tape when putting it in the VCR. Never force the tape into the VCR.
- If a timer recording is programmed and the VCR power is off, you can not insert a tape without a record tab.

Tape cannot be removed.

- Make sure the power plug is completely connected to an AC (alternating current) outlet.
- You have set a timer recording. Turn the VCR power on, then eject the tape. Be sure to insert a tape and turn off the power for your timer recording.

VCR ejects the tape when the REC(ord)/OTR button is pressed or when the VCR power is turned off to set a timer recording.

- Make sure the tape has a record tab (page five).

Channels above 13 cannot be received.

- Select CABLE TV at the TUNER SET UP menu (page 12), then let the VCR program the channels.

Poor reception

- You may need to tune your TV again.

The motor (cylinder) rotates even when the VCR is in Stop mode.

- To enable the quick play mechanism, the cylinder will rotate for about five minutes. This is normal.

Satellite Hookups

- Watching one TV channel while recording another may not be possible if you have a satellite hookup. You may have to set your TV to channel 3 or 4, then make your channel selections at the satellite converter box.
- With many satellite hookups, if you use accessory audio and video cables to connect your VCR to your TV, you will have to put your VCR in Line Input mode. To enter Line Input mode, press 0, 0, 1 or 0, 0, 2 on the VCR's remote control. AV REAR or AV FRONT will appear on your TV screen briefly.

Line Input mode

- If you accidentally enter Line Input mode (AV FRONT or AV REAR will appear on your TV screen briefly), press the CH(annel) Up/Down buttons or use the Number buttons to select another channel.

Daylight-Saving Time

- When automatic Daylight-Saving Time is set, the clock time will change automatically as follows: on the first Sunday in April, from 2 AM to 3 AM; on the last Sunday in October, from 2 AM to 1 AM.
- During the April time change, a timer recording programmed to start between 2 AM and 3 AM will not record. A timer recording programmed to end between 2 AM and 3 AM will end when the clock moves forward (2 AM).
- During the October time change, a recording cannot be started between the second 1 AM and 1:59 AM.

Hi-Fi Stereo Sound

- During playback, Hi-Fi audio may temporarily revert to normal audio when you adjust tracking. This is normal.
- When connecting the VCR to a stereo TV, you will only get stereo sound if you use audio cables to connect the AUDIO OUT jacks on the VCR to the AUDIO IN jacks on your TV, and if the TV is in Line (Auxiliary) Input mode.
- When you connect the AUDIO OUT jacks on the VCR to the AUDIO IN jacks on your TV, the stereo light on the TV might not glow. But, as long as the status display indicates you are receiving a stereo signal, you are receiving a stereo signal. This is normal.
- If Hi-Fi audio continually reverts to normal audio during playback, you may want to change AUDIO OUT to MONO at step 4 on page 56.
- Only tapes recorded in Hi-Fi audio will play back in Hi-Fi audio. Tapes recorded in normal audio will play back in monaural audio.

60 Glossary

AUDIO IN/OUT Jacks: jacks located on the front and back of the VCR which are used to record audio from another source (IN) or to send audio to another source (OUT).

Automatic Channel Programming: process in which the VCR scans all available channels and places the ones you receive in its memory. Then, when you push the CH(annel) Up/Down buttons, you only scan through channels you receive.

Bands: settings that allow you to tune channels.

- **Antenna** – VHF (very high frequency; channels 2 - 13) and UHF (ultra high frequency; channels 14 - 69).
- **Cable** – all standard channels can be received without a Cable Box.

Cable Box/DSS Receiver Output Channel: Channel 03 or 04.

Dubbing: copying a tape using a second VCR.

Frame: a single still picture.

HQ: high quality; a feature in the VCR circuitry which provides enhanced picture detail.

Line Input: The channel to which you set your VCR during dubbing. The line input channel is always channel 001 (AV REAR) or 002 (AV FRONT).

If you accidentally enter Line Input mode (AV REAR or AV FRONT will appear on your TV screen briefly), press the CH(annel) Up/Down buttons or use the Number buttons to select another channel.

Mode: a VCR operation.

OTR: one touch recording; programming a timed recording that starts immediately and records for 30 minutes to eight hours, whichever you specify.

Remote Control: the small electronic unit that came with your VCR; allows you to operate your VCR from a distance. You may be able to operate your TV, Cable Box or Digital Satellite System with the remote control.

RF coaxial cable: The cable supplied with your VCR. Use it to connect your VCR to your TV (or Cable Box/DSS Receiver, if applicable). The supplied cable is a snap-on type. However, you may also use a screw-on type if you prefer.

Special Effects: forward and reverse searching; viewing a still picture; slow motion.

Tape Speeds: how fast the tape travels during a recording or playback.

- **SP** (standard play) – fastest tape speed (recording time for a T120 tape is approximately two hours); best picture quality.
- **LP** (long play) – average tape speed (recording time for a T120 tape is approximately four hours).
- **SLP** (super long play) – slowest tape speed (recording time for a T120 tape is approximately six hours).

VCR: video cassette recorder.

VIDEO IN/OUT Jacks: jacks located on the front and back of the VCR which are used to record video from another source (IN) or send video to another source (OUT).

Specifications 61

Video Heads

Four heads – Hi-Fi

Video Signal

EIA standards; NTSC color

Antenna

VHF/UHF – 75 ohm external antenna terminal

VHF Output Signal

Channel 3 or 4 (switchable)

75 ohms unbalanced

Power Requirement

120V AC; 60Hz

Power Consumption

20W

Operating Temperature

41°F (5°C) to 104°F (40°C)

Relative Humidity

10% to 80%

Weight

6.83 lbs. (3.1 kg.)

Dimensions

15" (W) x 3-1/16" (H) x 10" (D)

(380 mm x 92mm x 230mm)

Tuner Broadcast Channels

VHF 2 - 13, UHF 14 - 69

Cable TV Channels

2 - 13

Midband: A – 1

Superband: J – W

Hyperband: A-5 – A-1

Special Channel: 5A

Ultraband: 37 – 94, 100 – 125

NOTE: Designs and specifications are subject to change without notice.

**RENEWED
90 DAY
LIMITED WARRANTY**

Index 63

- ac power cord.....29
accessories64
ant(enna) in jack.....6-10, 29
audio in/out jacks.....
.....10, 28, 29, 44, 54, 60
automatic
 playback52
 rewind, eject, off.....52

batteries5

cable box controller.....38 - 39
cable box transmitters28, 38
cassette compartment27
cassette-inside light27
cbl/dss button5, 21, 23
ch3/ch4 switch6-9, 29
channel
 above 100.....23
 adding13
 deleting13
 memory12
 programming12
 reviewing13
 up/down buttons25, 28, 53
clear button.....25, 49
clock display27
clock setting.....14-17
connections44, 54
contents, table of4
controls
 remote23 - 25
 vcr28 - 29
counter only mode.....26

daylight-saving time18
display panel27
duplication44

eject button.....25
erase prevention5

fast forward button.....24, 50
front panel.....28

glossary.....60

helpful hints58 - 59
hi-fi stereo sound system.....56 - 57
hookups
 with cable box8 - 9
 with stereo tv.....10
 without cable box.....6 - 7

language selection.....11, 19
line input mode44, 60
long play36, 60
lp36, 60
memory button.....25, 49
menu button25
mts broadcast stereo system.54 - 55
mute button24
number buttons23
on screen off mode.....26
on screen on mode.....26
on screen status displays26
one touch recording33
out jack6-9, 29
pause button28
pause/still button.....24, 31, 50
play button23, 30, 50, 51
playing30
power
 button.....24, 28
 cord29
rear panel29
rec(ord)/otr button.....24, 31, 33
recording
 basic.....31
 one channel/
 watching another32
 timer34 - 37
 with the vcr plus+
 programming system40 - 43
remote control
 buttons.....23 - 25
 sensor.....28
 using.....5
repeat playback45
rerecording44
rewind button.....23, 50
rf coaxial cable6-9, 44, 54
safety precautions3
satellite hookups59
searching.....50
second audio broadcast
 receiving54 - 55
 recording.....54 - 55
sensor (remote).....28
slow
 button.....25, 51
 motion.....51
slp36, 60
sp36, 60
speed button.....25
standard play.....36, 60
status display.....26
status/exit button.....23, 26
stereo
 broadcast
 receiving54 - 55
 recording.....54 - 55
 hookups54
still picture.....50
stop button25
stop/eject button28
super high speed searching50
super long play36, 60

table of contents4
tape
 duplication.....44
 eject25, 28, 52
 speed36, 60
time
 (setting).....14-17
timer
 light27
 recording
 cancelling.....37
 checking.....37
 setting34 - 37
 with vcr plus+ programming
 system.....40 - 43
tracking.....53
tv
 button5, 20, 23
 controls5, 20, 23 - 25
 hookups6-10
 position25, 28
vcr
 button.....5, 23
 light27
 plus+
 programming system40 - 43
 plus+/enter button...20 - 21, 24,
 42 - 43
 position25, 28
vcr/tv button25, 32
video
 in/out jacks10, 28, 29, 44, 54, 60
 vol(ume) up/down buttons.....24
warranty.....62

SUPPLIED ACCESSORIES

Check to be sure the items on this page are packed with your VCR. These accessories are provided to help you use or set up your VCR.

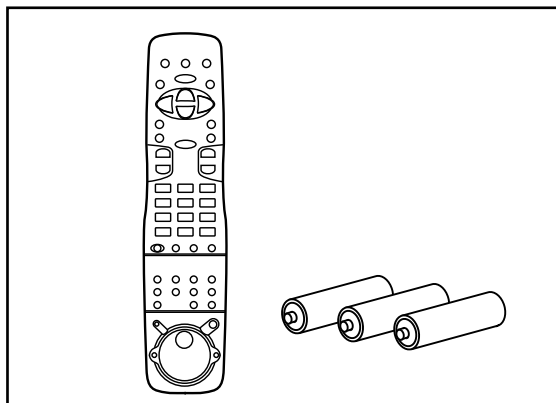

**Remote Control 4835 218 37205
Three "AA" Batteries 4835 138 17012**

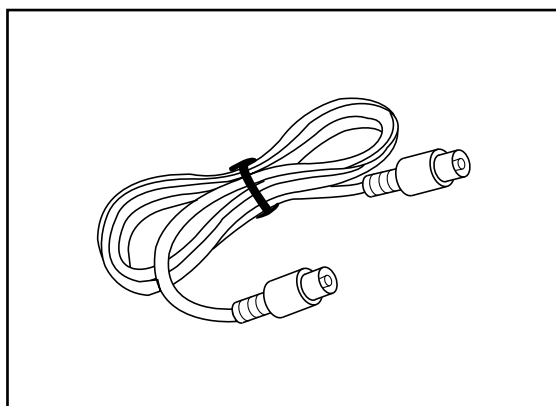

RF Coaxial Cable, 75 ohm 4835 323 27011

If any of these items are not included, or if you need to replace an item, contact Philips Service Company at the address below.

***Philips Service Company
P.O. Box 967
Greeneville, TN 37744-0967***

Or, call 1-800-851-8885.